

Solar cell operating principles

Solar cell operation is based on the photovoltaic effect:

The generation of a voltage difference **at the junction** of two different materials in response to visible or other radiation.

1. **Absorption** of light - **Generation** of charge carriers
2. **Separation** of charge carriers
3. **Collection** of the carriers at the electrodes

Solar cell operating principles

Thermodynamic approach:

Conversion of energy of solar radiation into electrical energy

Two-step process:

1. **Solar heat** → **Chemical energy** of electron-hole pairs
2. **Chemical energy** → **Electrical energy**

Solar cell operating principles

1. Solar heat → Chemical energy of electron-hole pairs

- Non-equilibrium carrier concentration
- Quasi-Fermi energies

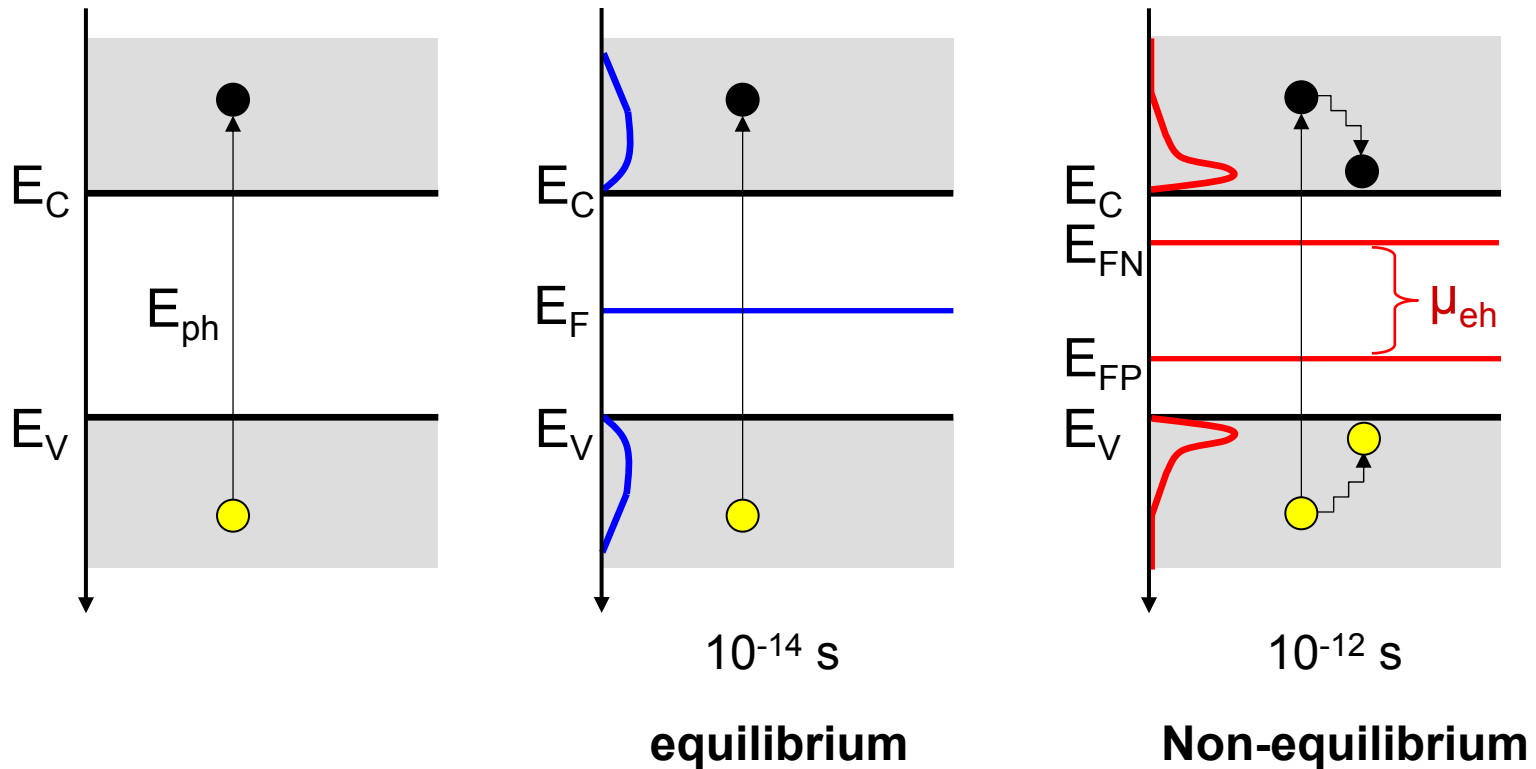

Solar cell operating principles

- Solar cell:**
- Absorber layer
 - Semi-permeable membranes

X_e electron affinity

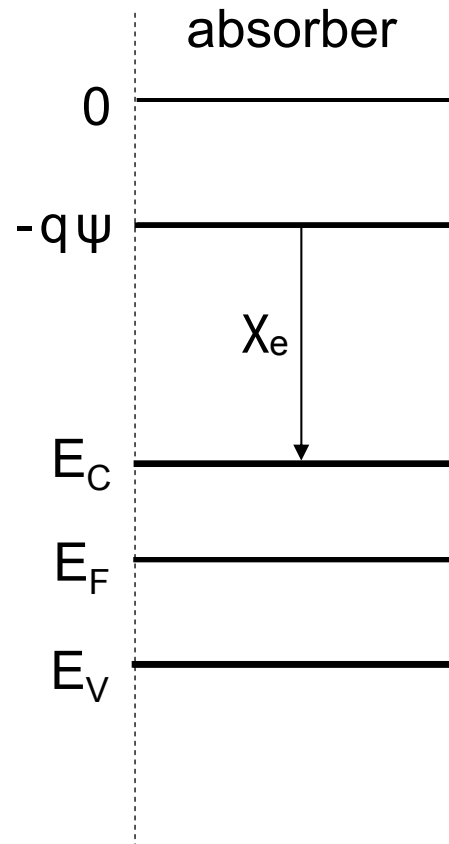

Solar cell operating principles

- Solar cell:**
- Absorber layer
 - Semi-permeable membranes

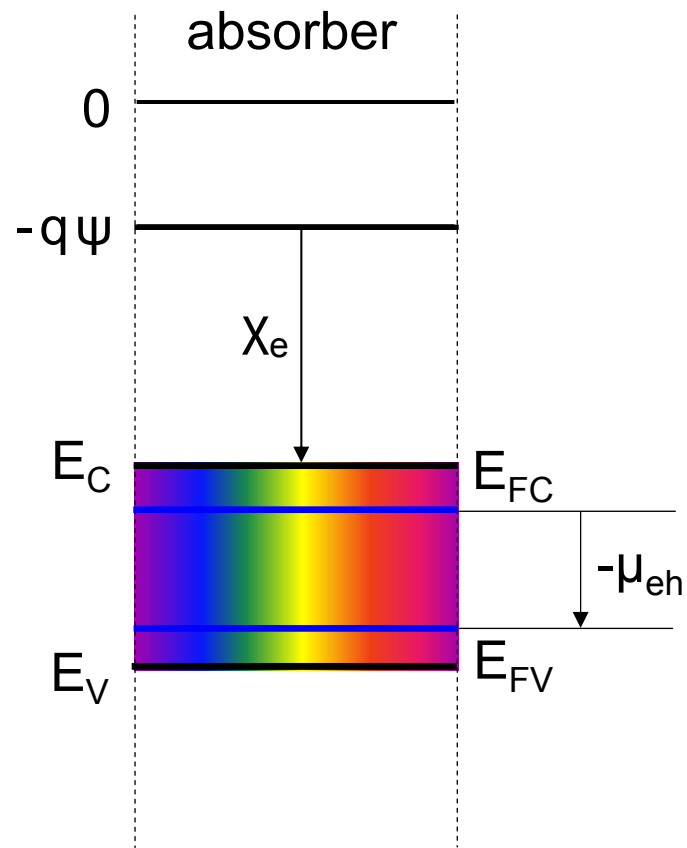

Solar cell operating principles

- Solar cell:**
- Absorber layer
 - Semi-permeable membranes

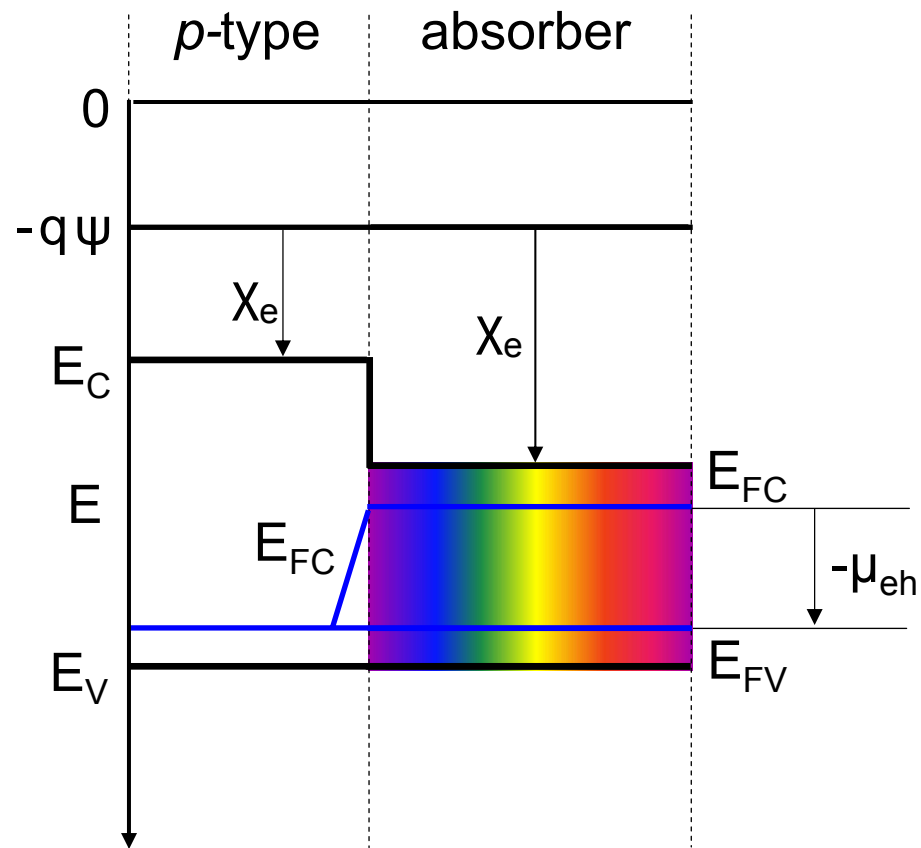

Solar cell operating principles

- Solar cell:**
- Absorber layer
 - Semi-permeable membranes

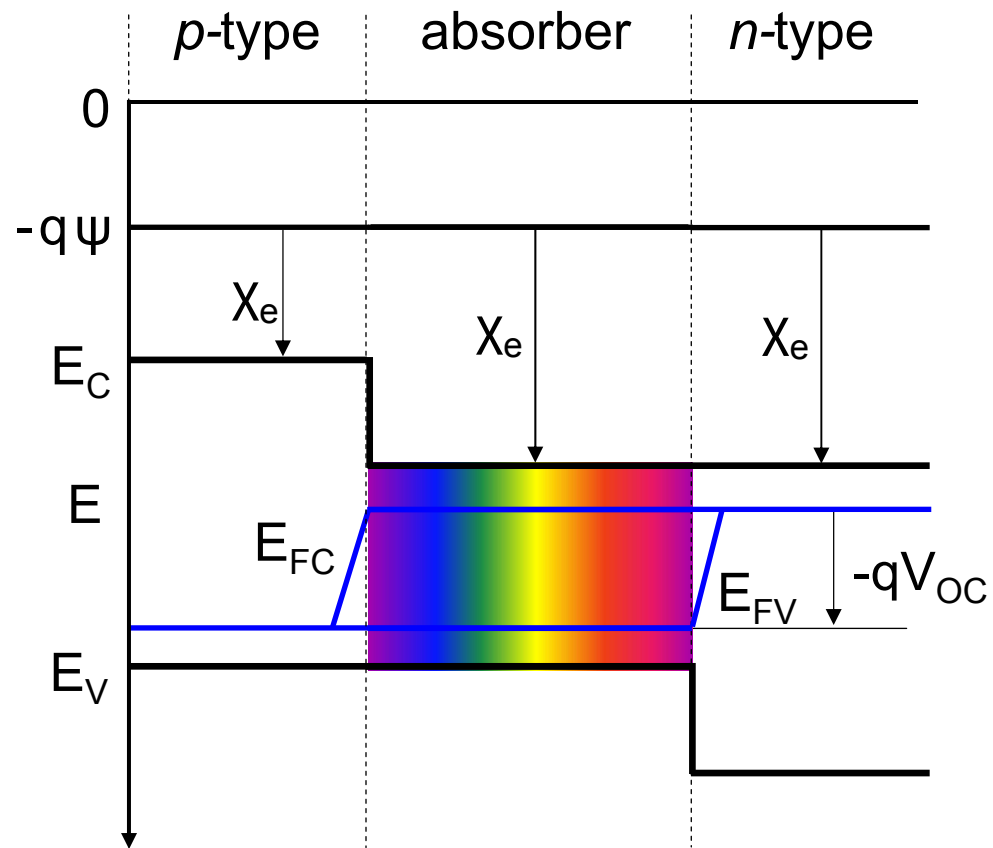

Solar cell operating principles

- Solar cell:**
- Absorber layer
 - Semi-permeable membranes

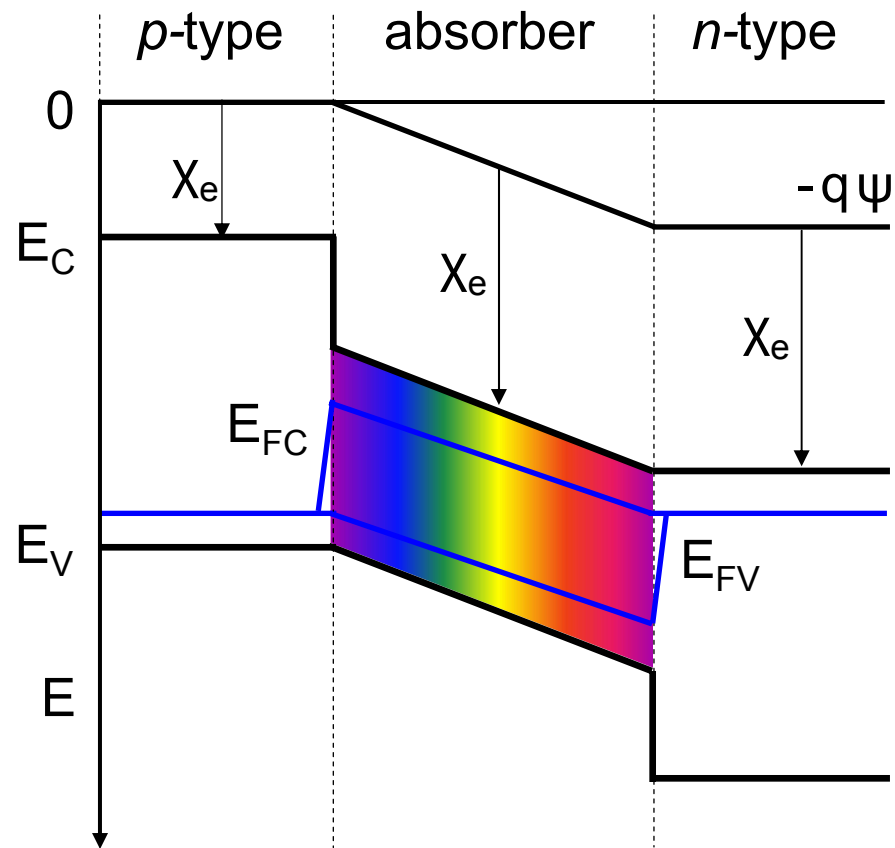

Semiconductor solar cells

p-n junction

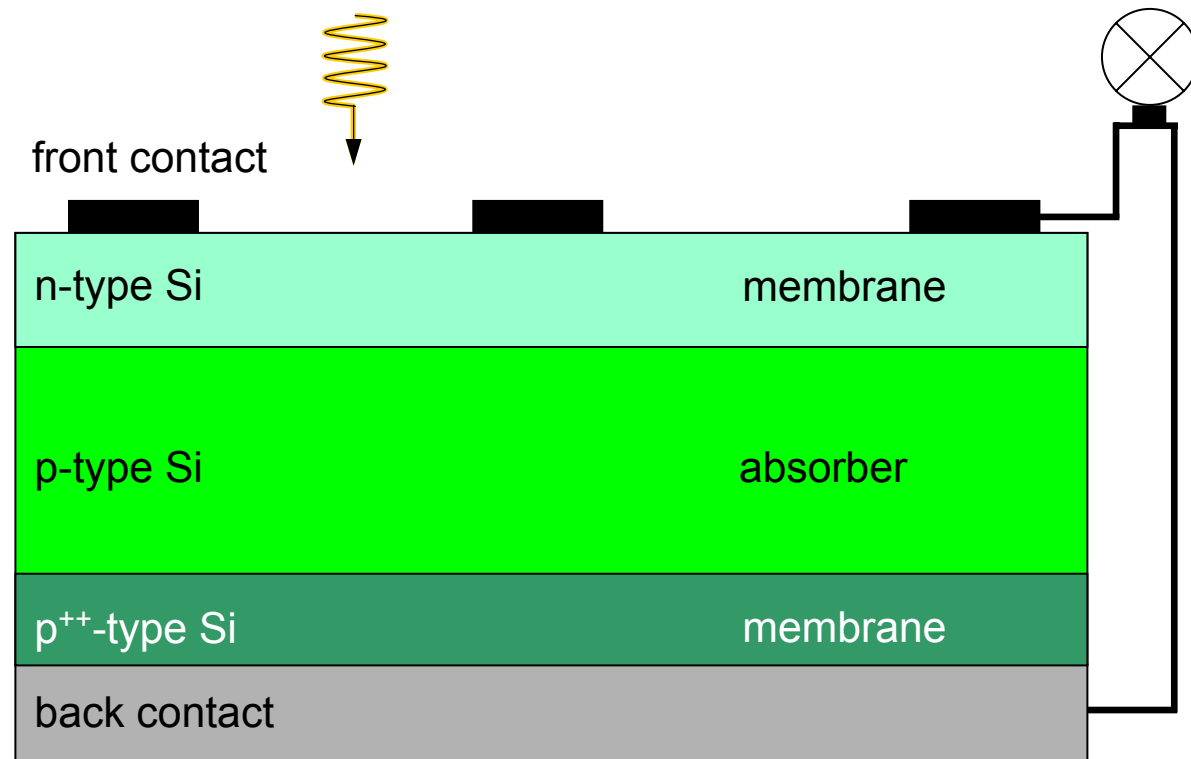

Semiconductor solar cells

p-n junction

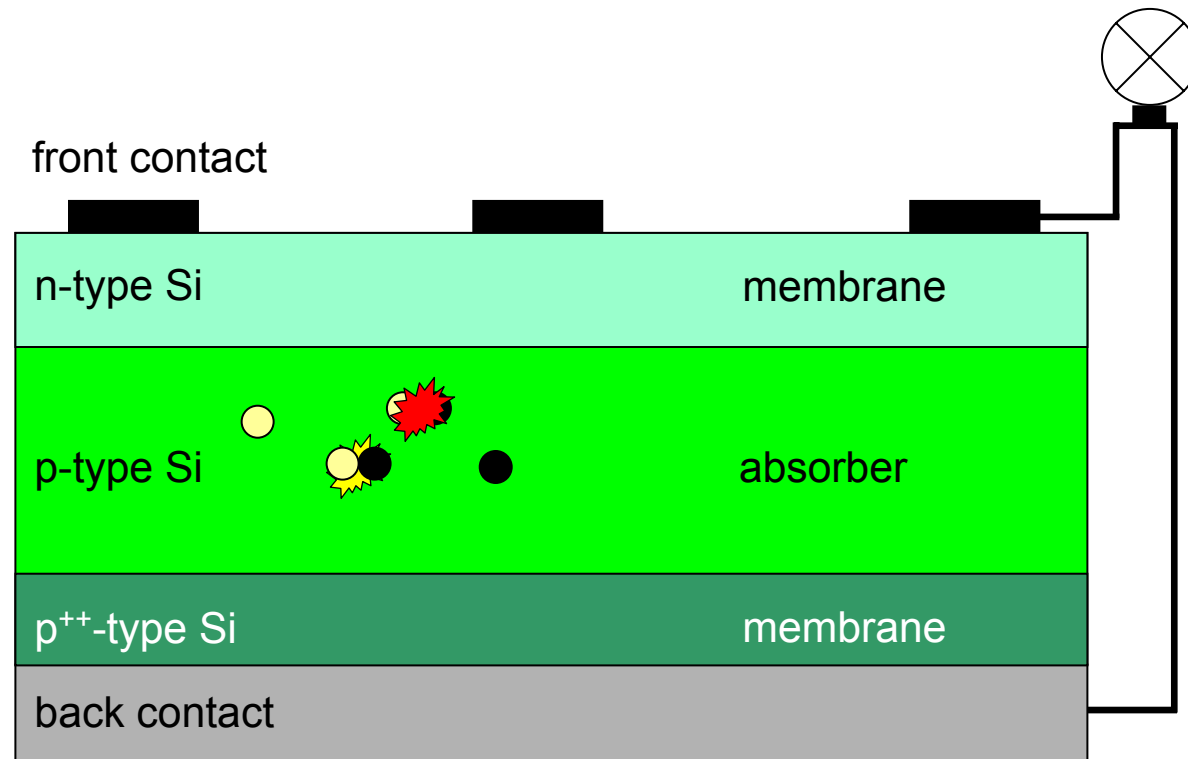

Semiconductor solar cells

p-n junction

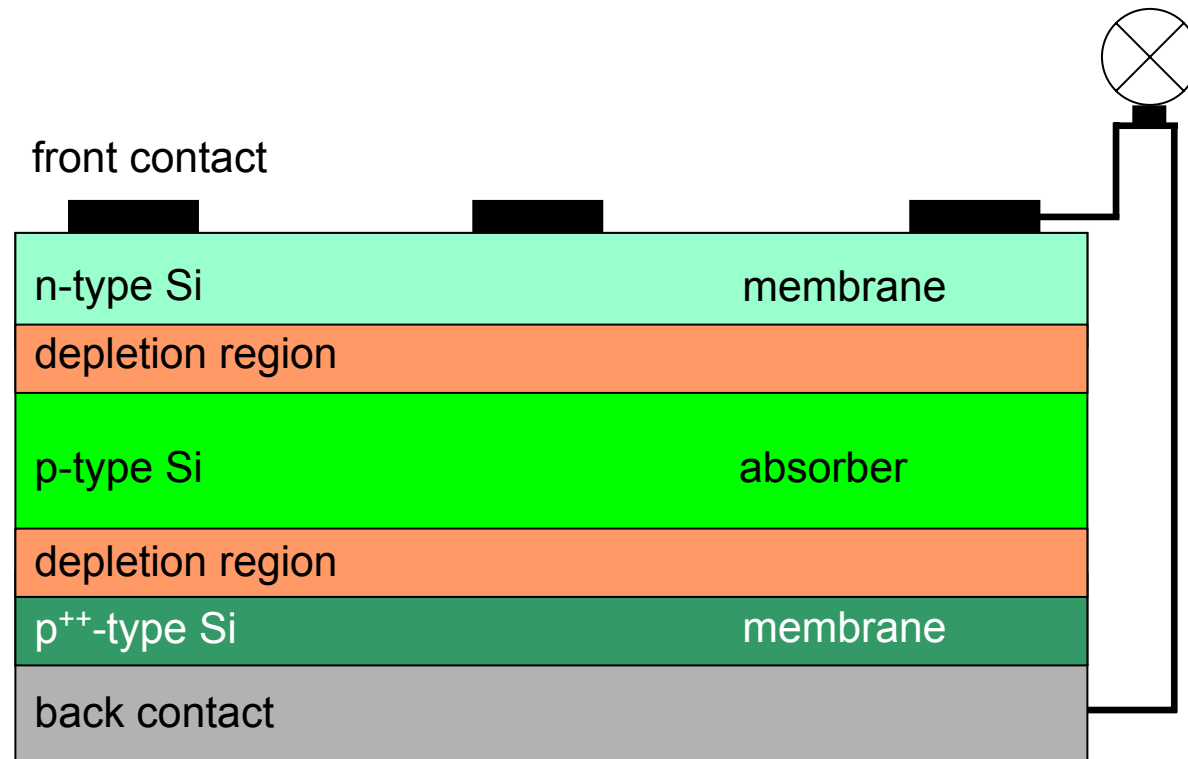

Semiconductor solar cells

p-n junction

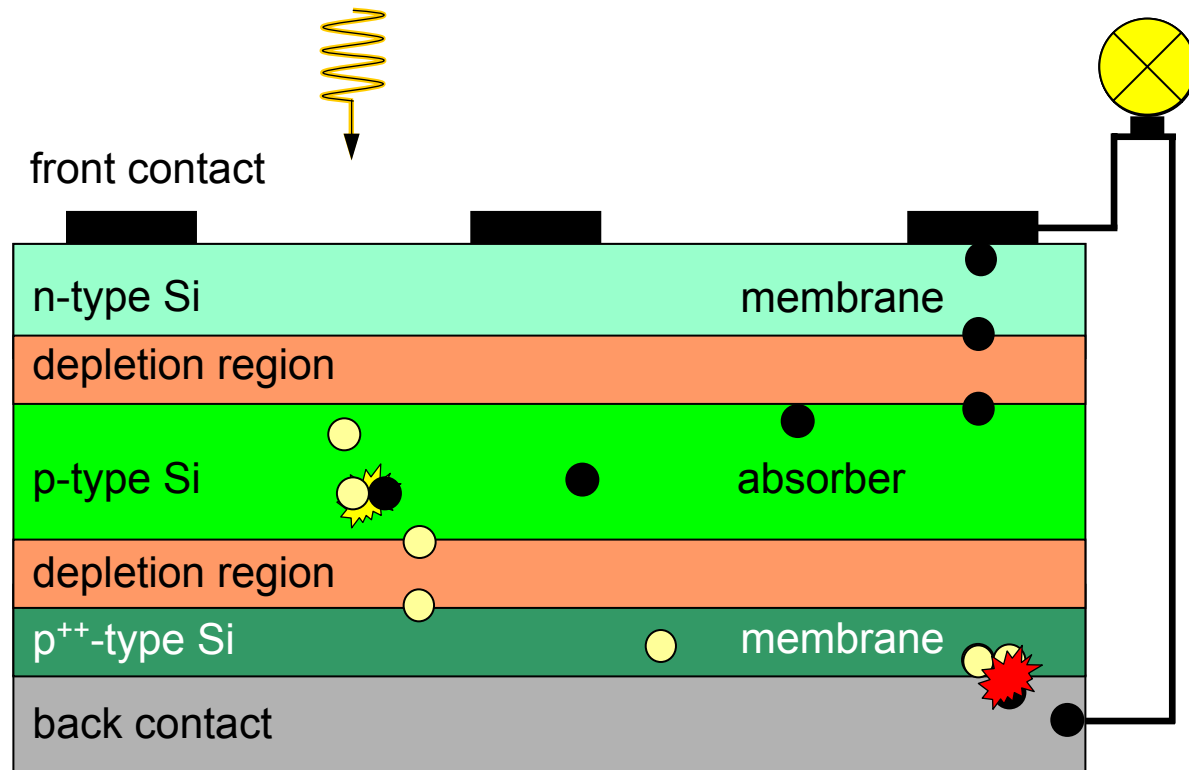

Semiconductor solar cells

p-n junction

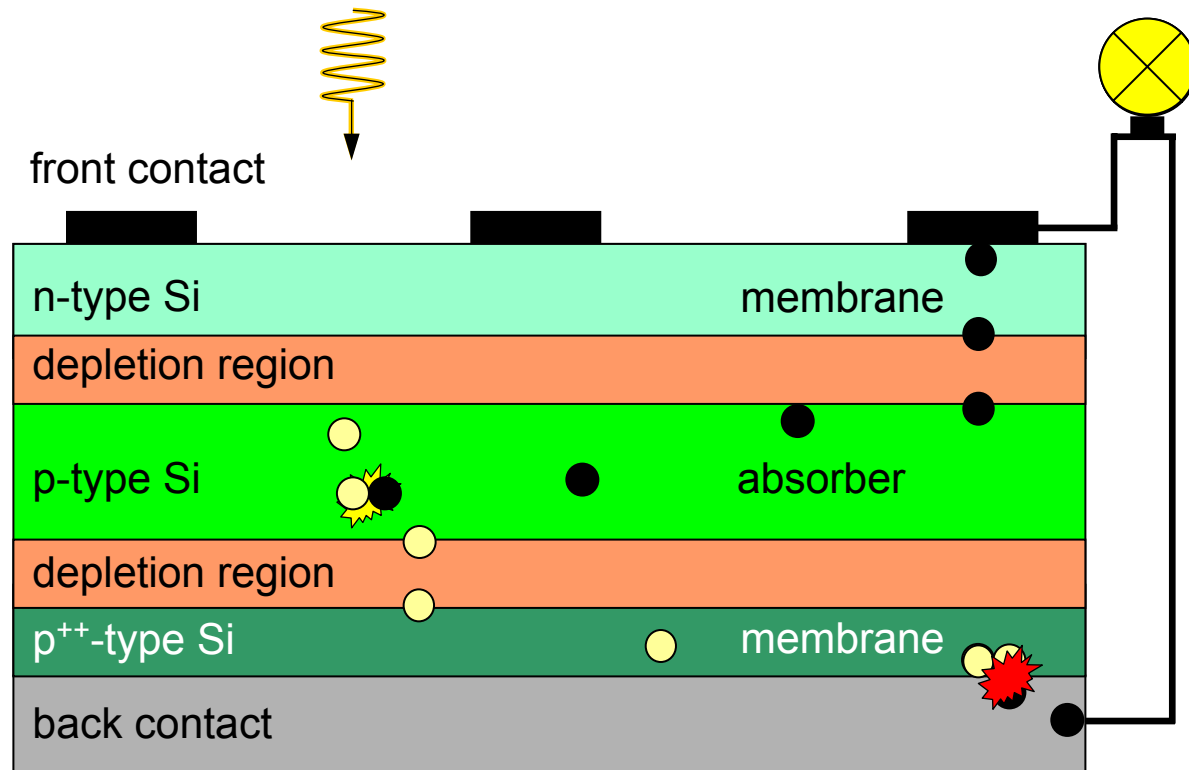

p-n junction

Thermal equilibrium:

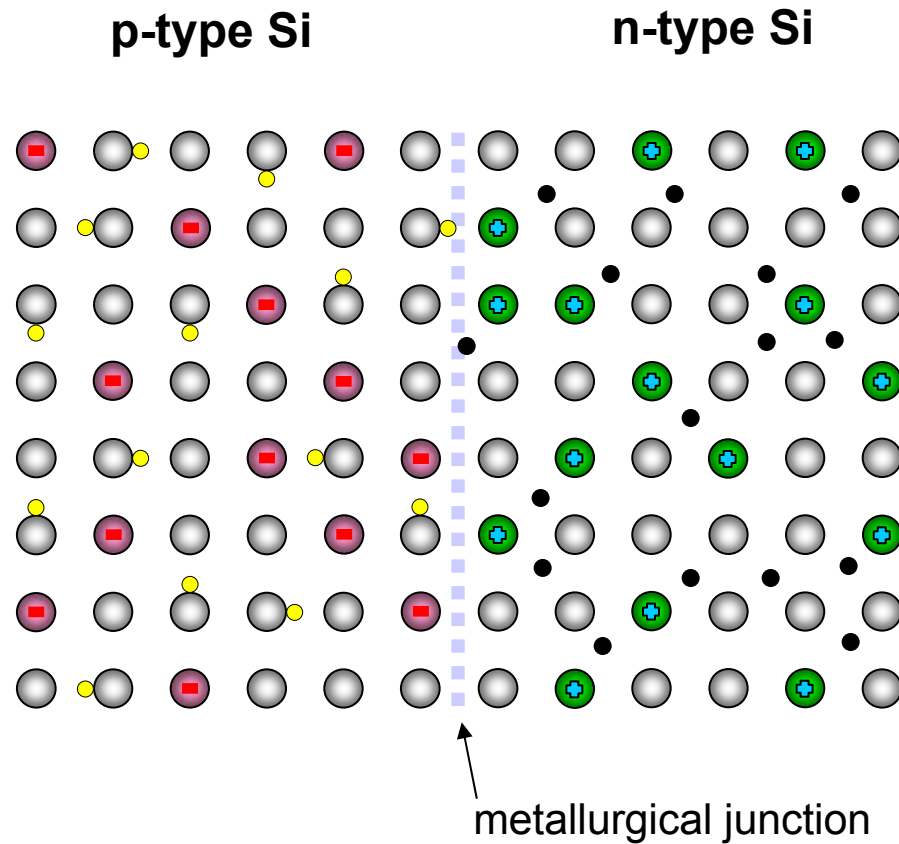

p-n junction

Thermal equilibrium:

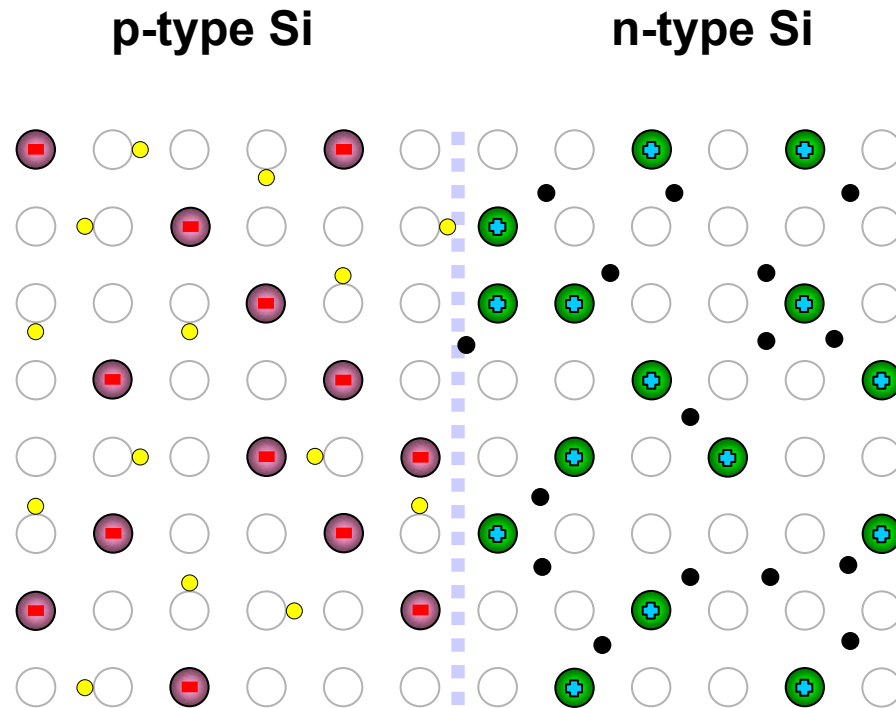

p-n junction

Thermal equilibrium:

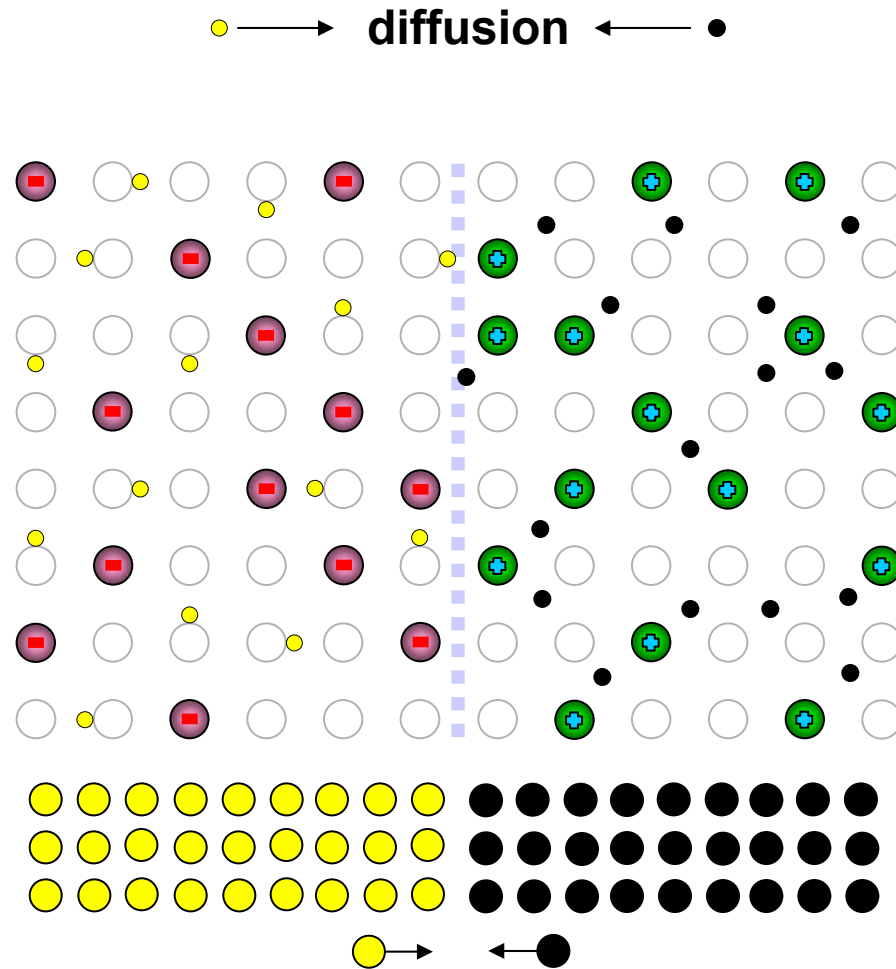

p-n junction

Thermal equilibrium:

● → diffusion ← ●

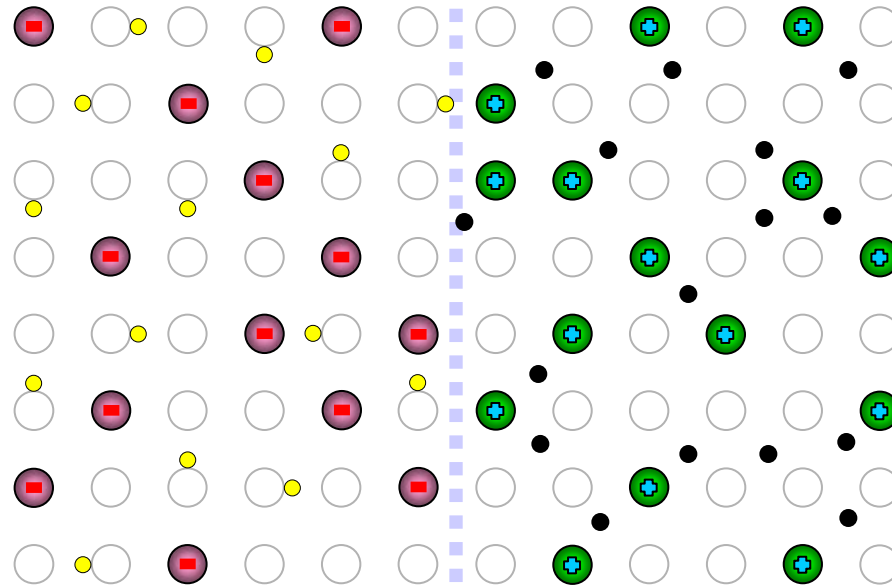

p-n junction

Thermal equilibrium:

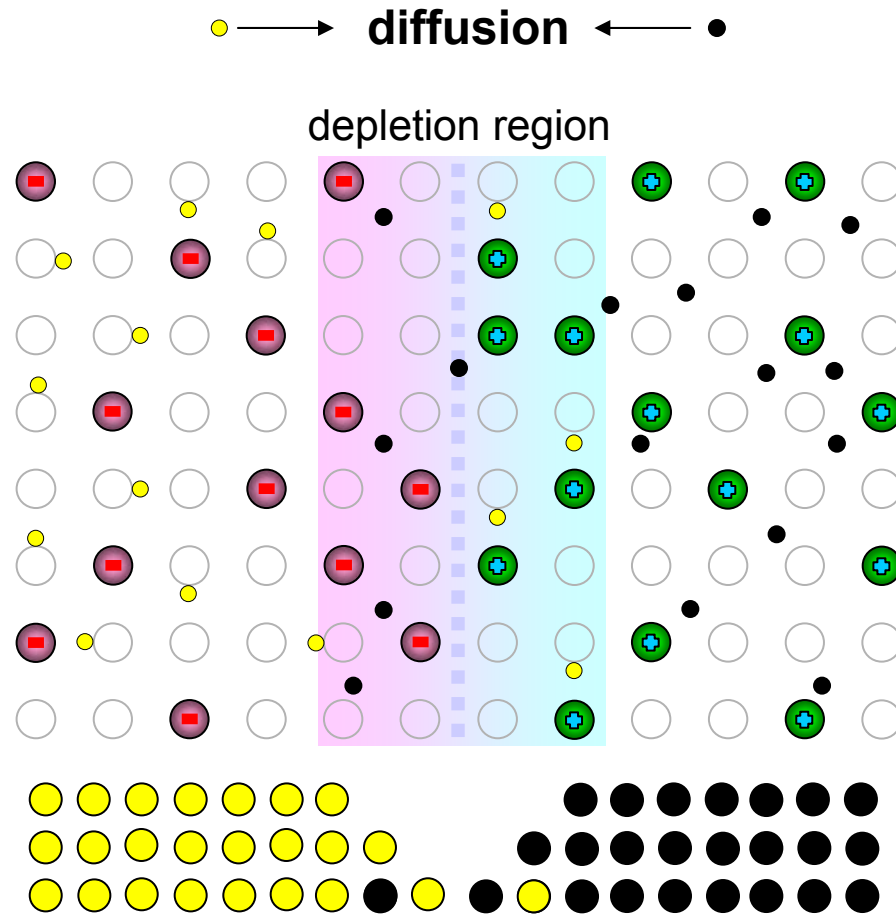

p-n junction

Thermal equilibrium:

● → diffusion ← ●

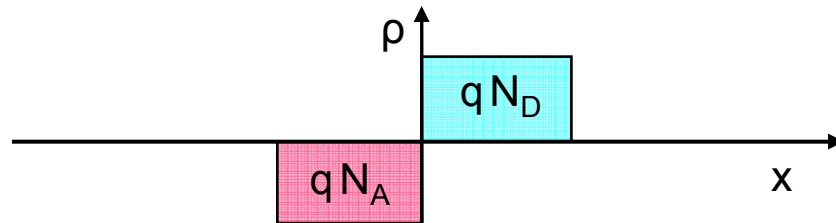
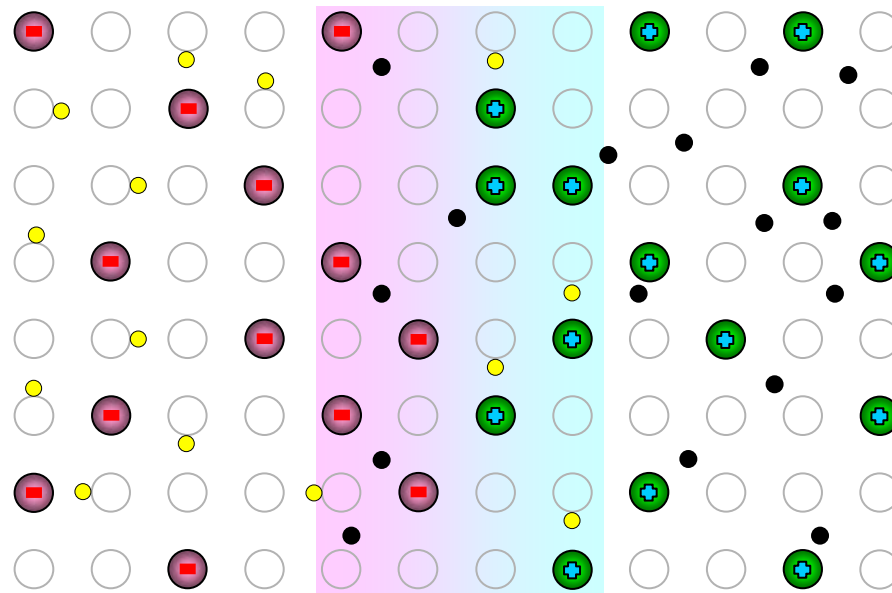

p-n junction

Thermal equilibrium:

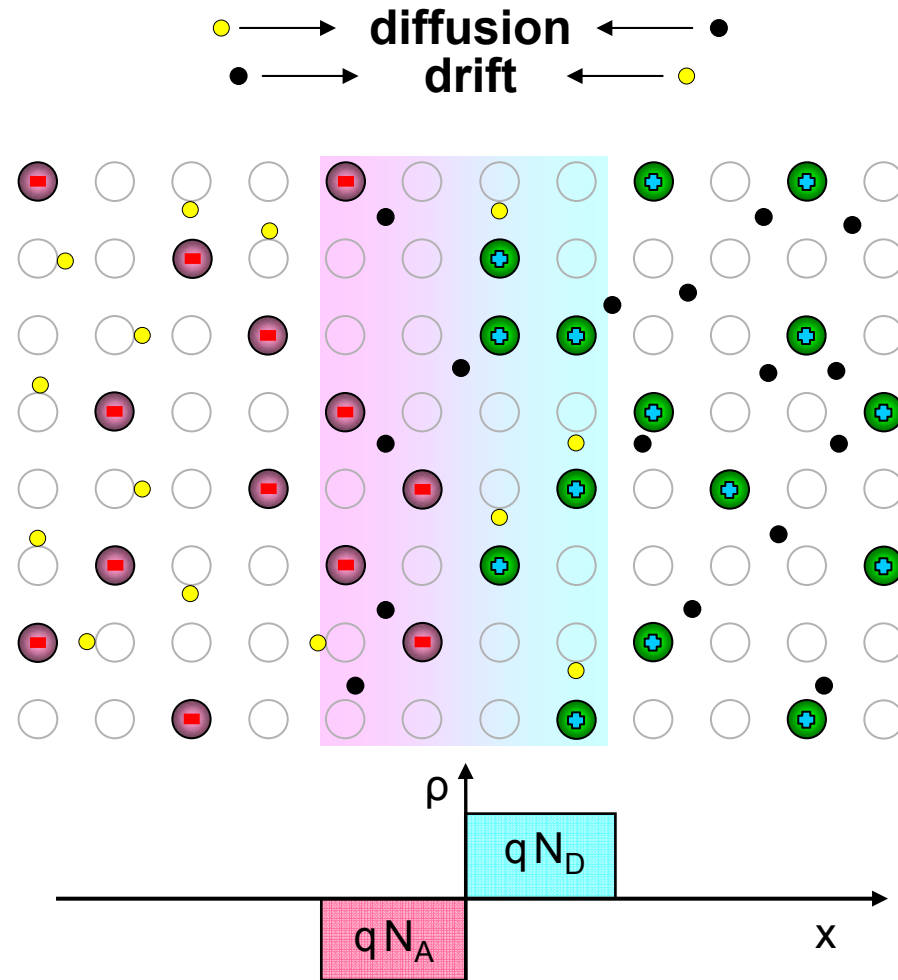

p-n junction

Thermal equilibrium:

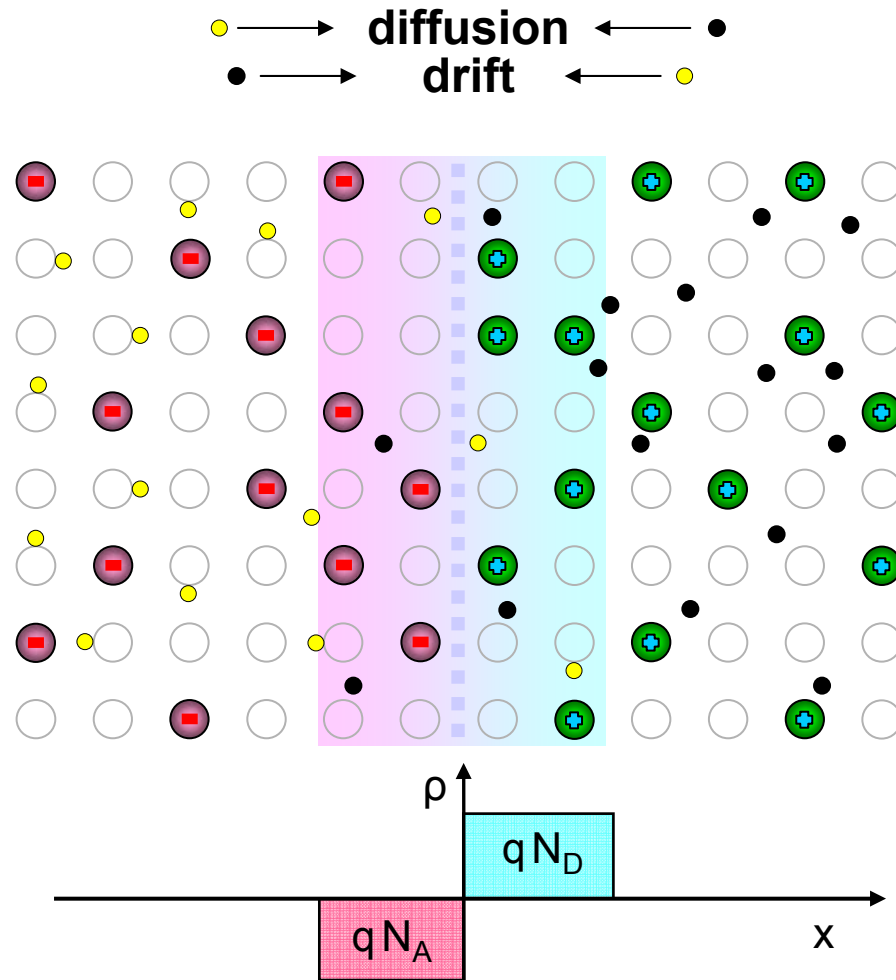

p-n junction

How thick is the depletion region?

How big is the electric field in the depletion region?

Thermal equilibrium?

What happens when we apply voltage at the junction?

What happens when we illuminate the junction?

p-n junction

Thermal equilibrium:

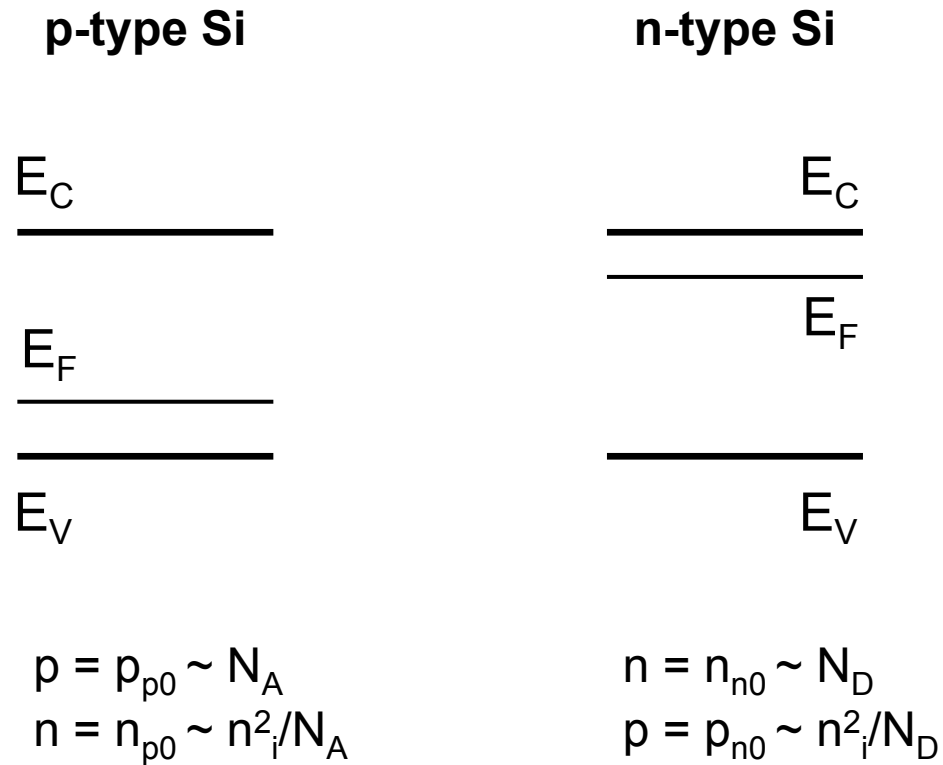

p-n junction

Thermal equilibrium:

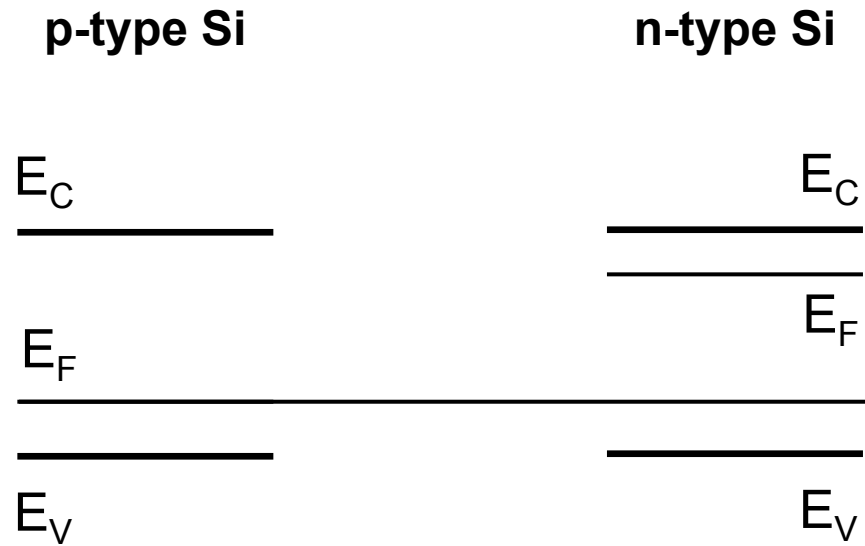

p-n junction

Thermal equilibrium:

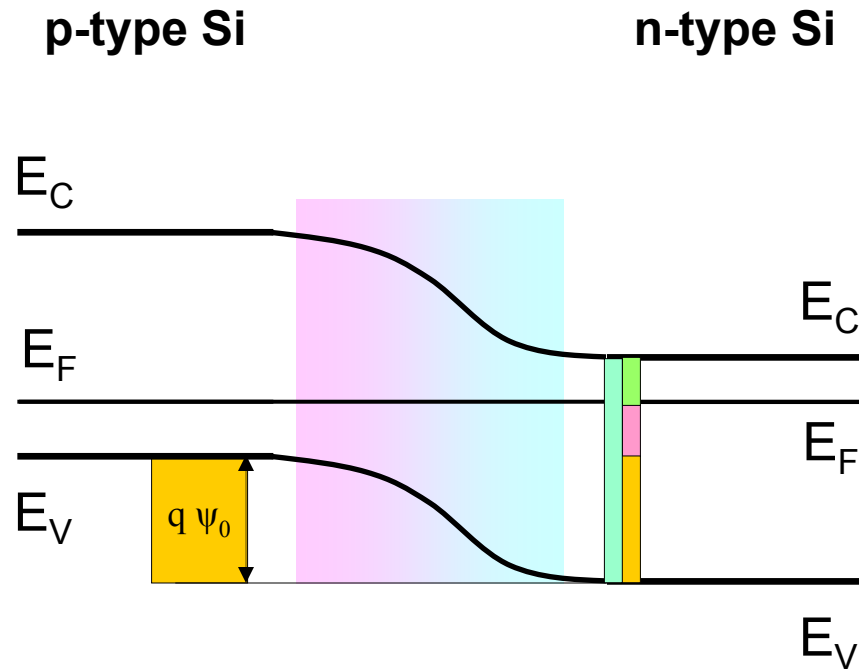

$$q\psi_0 = E_G - E_{Fn} - E_{Fp} = kT \ln\left(\frac{N_A N_D}{n_i^2}\right)$$

$$E_{Fn} = kT \ln(N_C / N_D)$$

$$E_{Fp} = kT \ln(N_V / N_A)$$

p-n junction

Thermal equilibrium: Band diagram

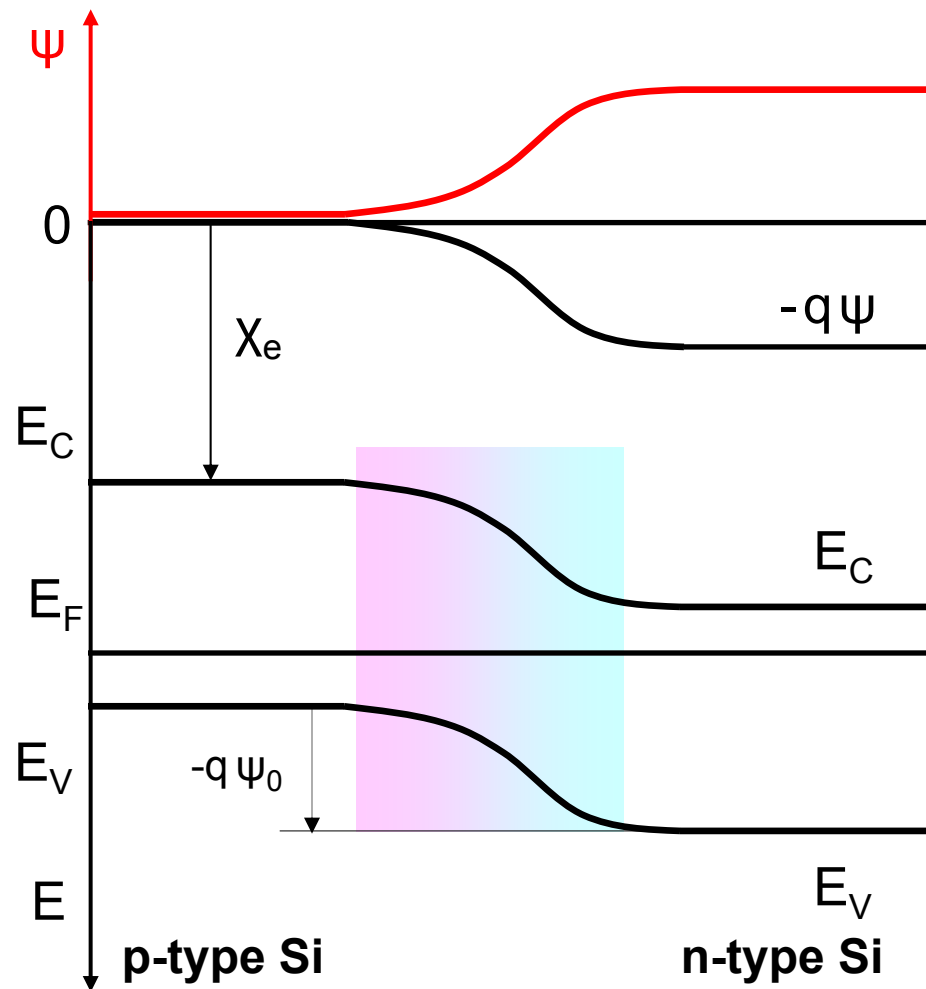

p-n junction

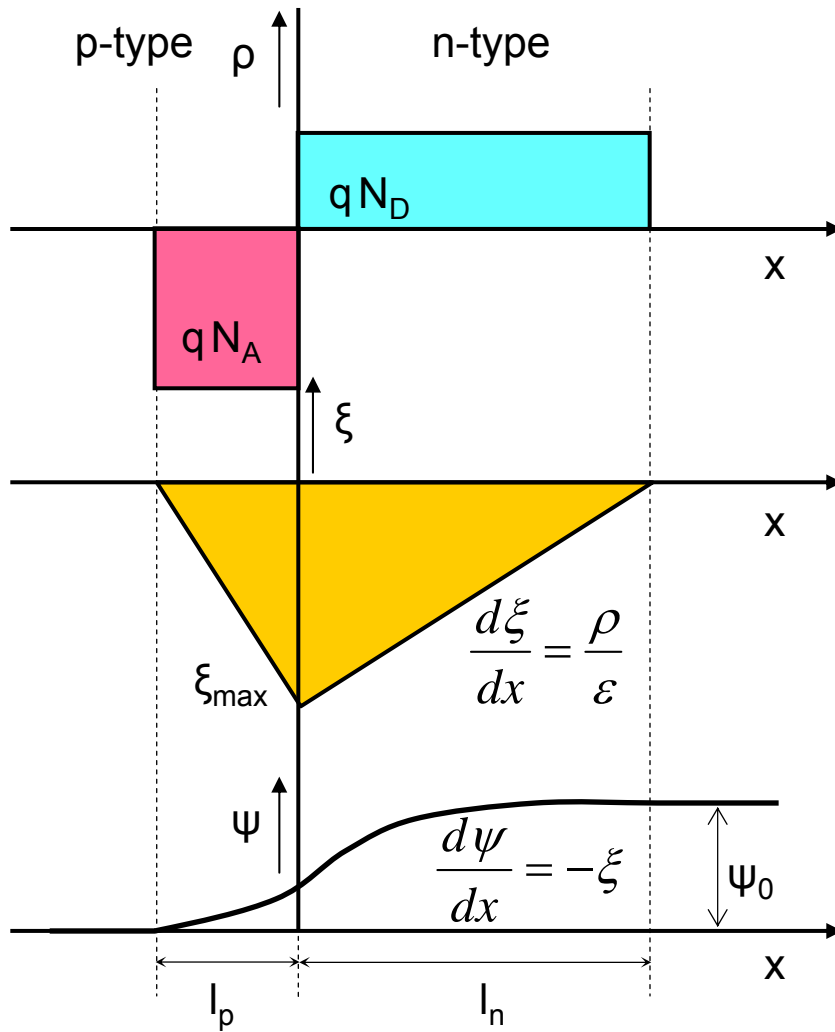

$$l_p = W \frac{N_D}{N_A + N_D} \quad l_n = W \frac{N_A}{N_A + N_D}$$

$$W = l_p + l_n$$

$$W = \left[\frac{2\epsilon}{q} (\psi_0 - V_A) \left(\frac{1}{N_A} + \frac{1}{N_D} \right) \right]^{1/2}$$

$$\xi_{\max} = - \left[\frac{2\epsilon}{q} \frac{(\psi_0 - V_A)}{\left(\frac{1}{N_A} + \frac{1}{N_D} \right)} \right]^{1/2}$$

p-n junction

Thermal equilibrium:

Input:

$$n_i = 1.5 \times 10^{10} \text{ cm}^{-3}$$

$$N_C = 3.22 \times 10^{19} \text{ cm}^{-3}$$

$$N_V = 1.83 \times 10^{19} \text{ cm}^{-3}$$

$$N_D = 1 \times 10^{18} \text{ cm}^{-3}$$

$$N_A = 1 \times 10^{16} \text{ cm}^{-3}$$

$$\epsilon_r = 11.7$$

$$k = 1.38 \times 10^{-23} \text{ JK}^{-1}$$

$$q = 1.602 \times 10^{-19} \text{ cm}^{-3}$$

$$\epsilon_0 = 8.854 \times 10^{-14} \text{ Fcm}^{-1}$$

Thermal equilibrium ($T=300 \text{ K}$, $V_A=0 \text{ V}$):

$$p_{p0} = N_A = 1 \times 10^{16} \text{ cm}^{-3} \quad n_{n0} = N_D = 1 \times 10^{18} \text{ cm}^{-3}$$

$$n_{p0} = n_i^2 / N_A = 2.25 \times 10^4 \text{ cm}^{-3} \quad p_{n0} = n_i^2 / N_D = 2.25 \times 10^2 \text{ cm}^{-3}$$

$$\psi_0 = \frac{kT}{q} \ln \left(\frac{N_A N_D}{n_i^2} \right) = 0.81 \text{ V}$$

$$W = \left[\frac{2\epsilon}{q} (\psi_0 - V_A) \left(\frac{1}{N_A} + \frac{1}{N_D} \right) \right]^{1/2} = 0.33 \text{ } \mu\text{m}$$

$$\xi_{\max} = - \left[\frac{2q}{\epsilon} (\psi_0 - V_A) \right] / \left(\frac{1}{N_A} + \frac{1}{N_D} \right) \right]^{1/2} = 50 \times 10^3 \frac{\text{V}}{\text{cm}}$$

$$l_p = W \frac{N_D}{N_D + N_A} = 0.326 \text{ } \mu\text{m} \quad l_n = W - l_p = 0.0033 \text{ } \mu\text{m}$$

p-n junction

Thermal equilibrium:

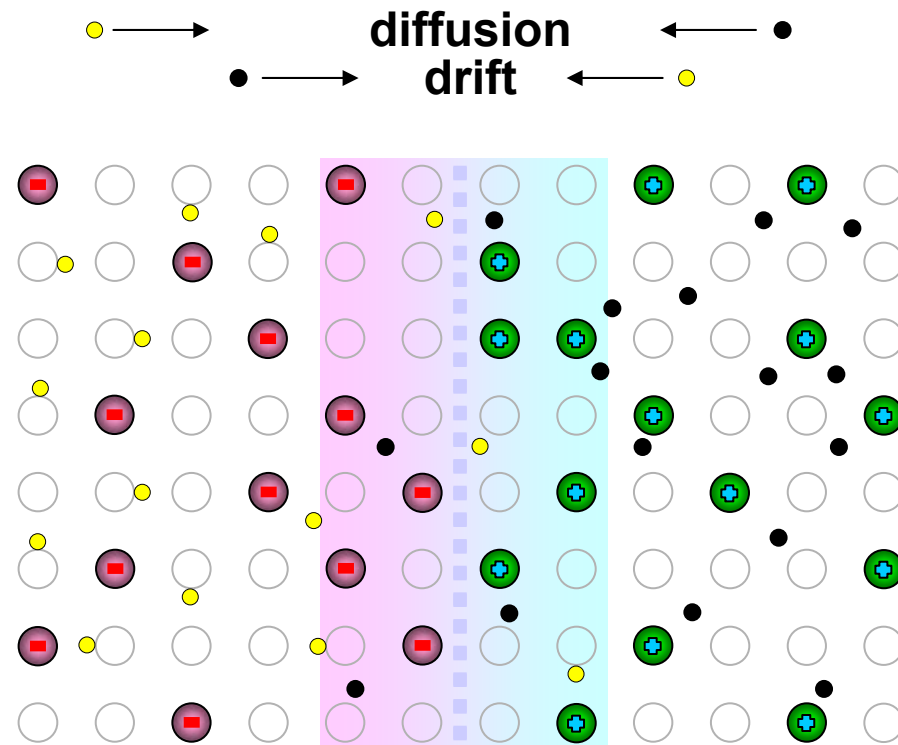

p-n junction diode

Applied voltage: Forward bias

● → diffusion ← ●

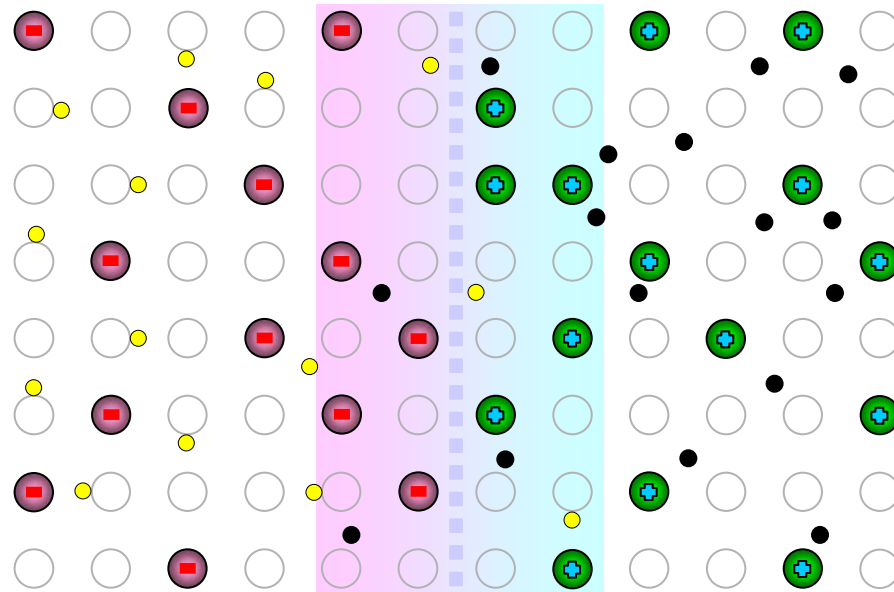

p-n junction diode

Applied voltage: Forward bias

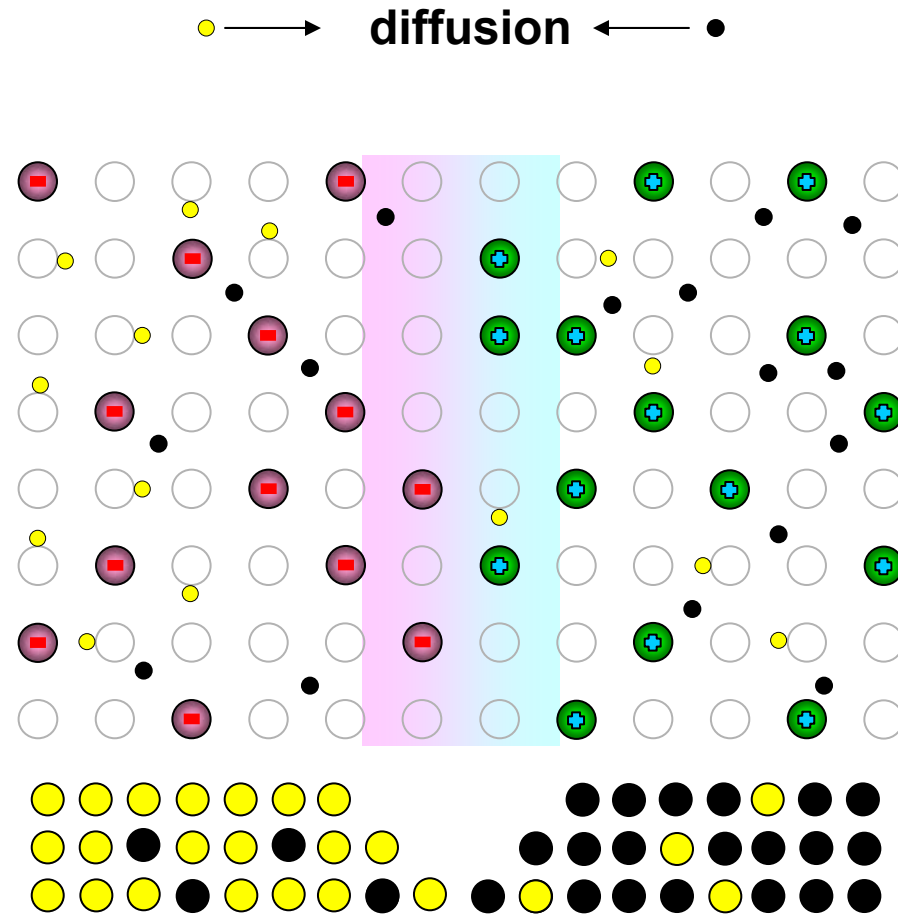

p - n junction diode

Applied voltage: Forward bias

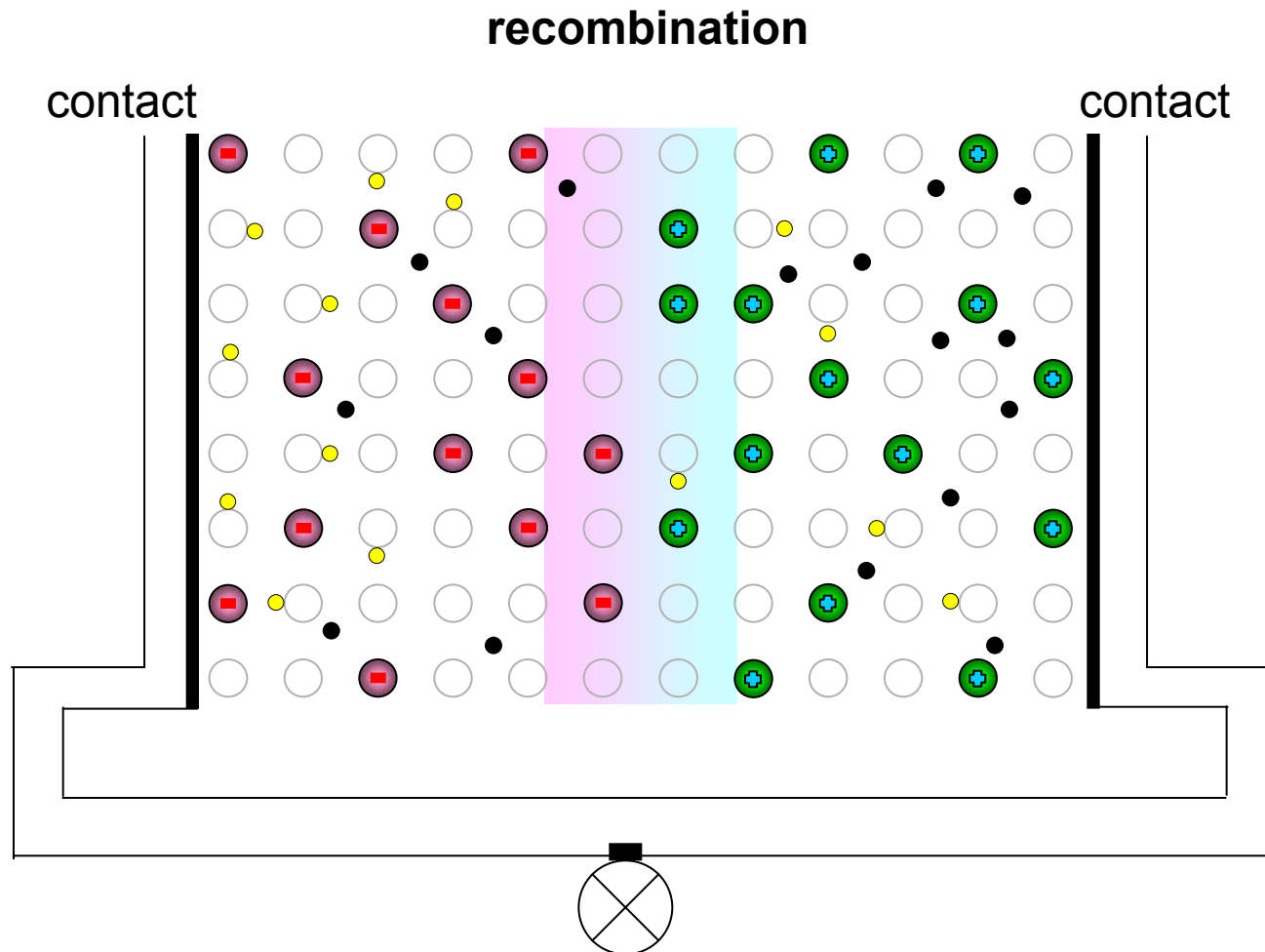

p - n junction diode

Applied voltage: Forward bias

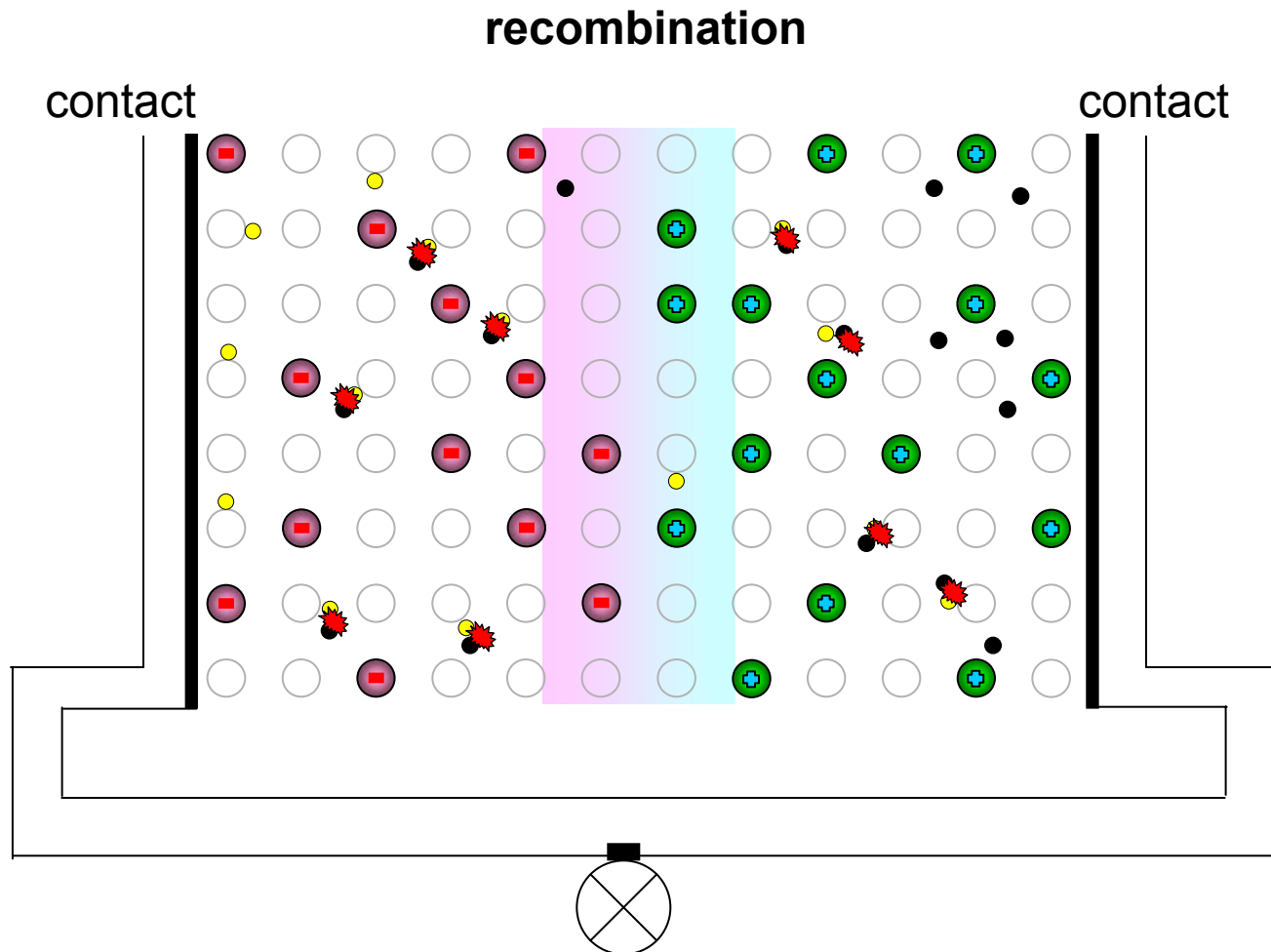

p-n junction diode

Applied voltage: Forward bias

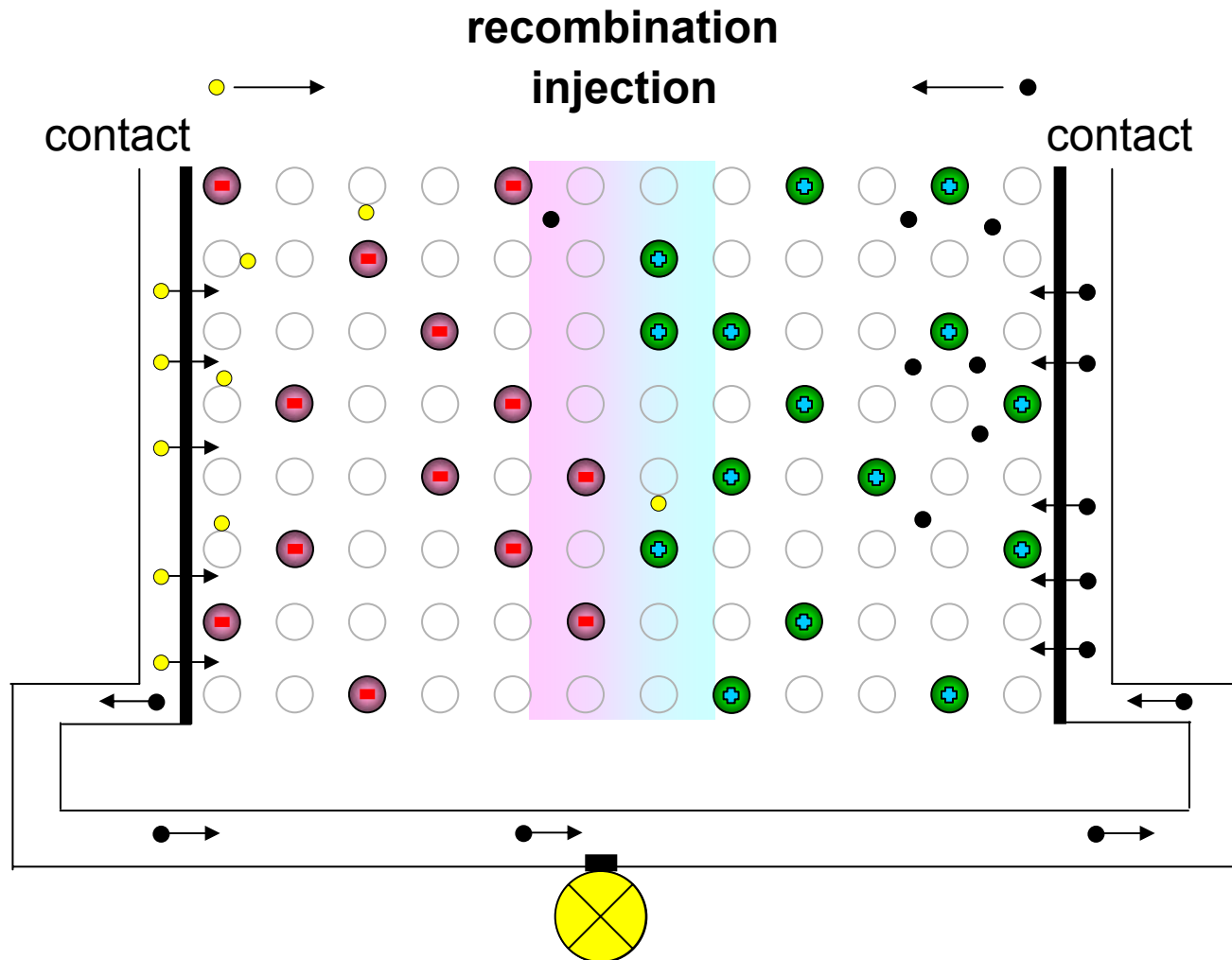

p-n junction diode

Applied voltage: Forward bias

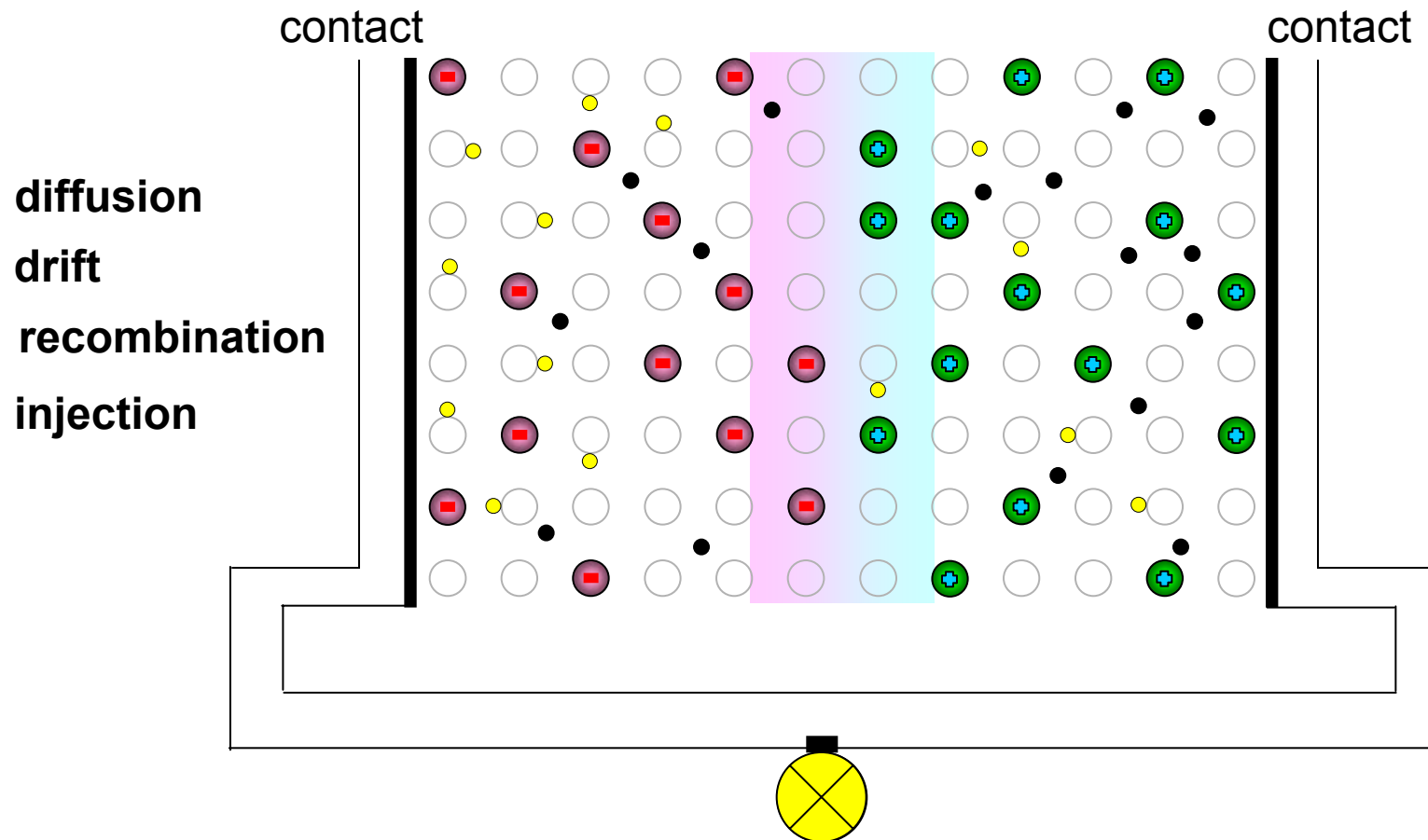

p-n junction diode

Applied voltage: Forward bias

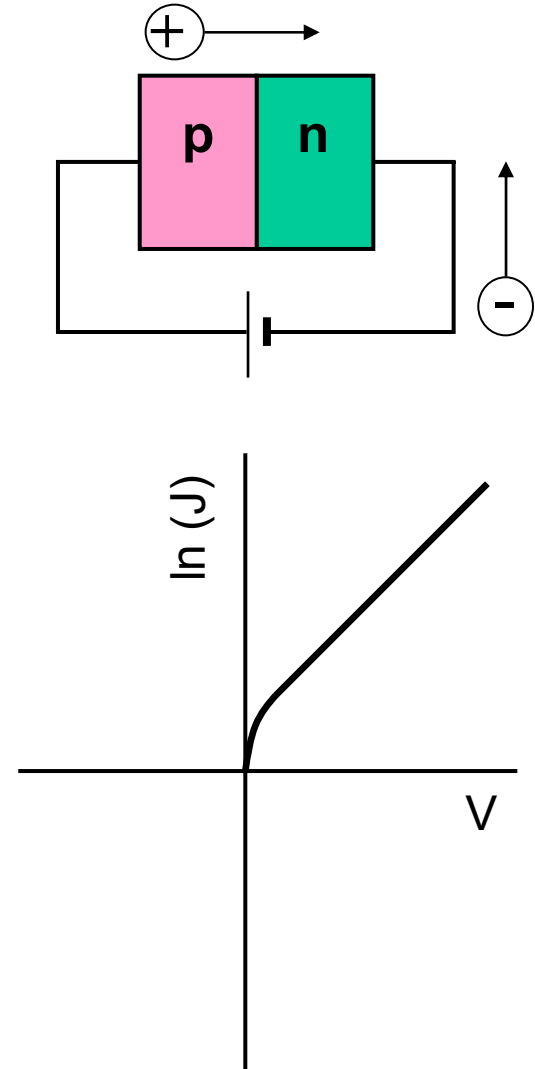
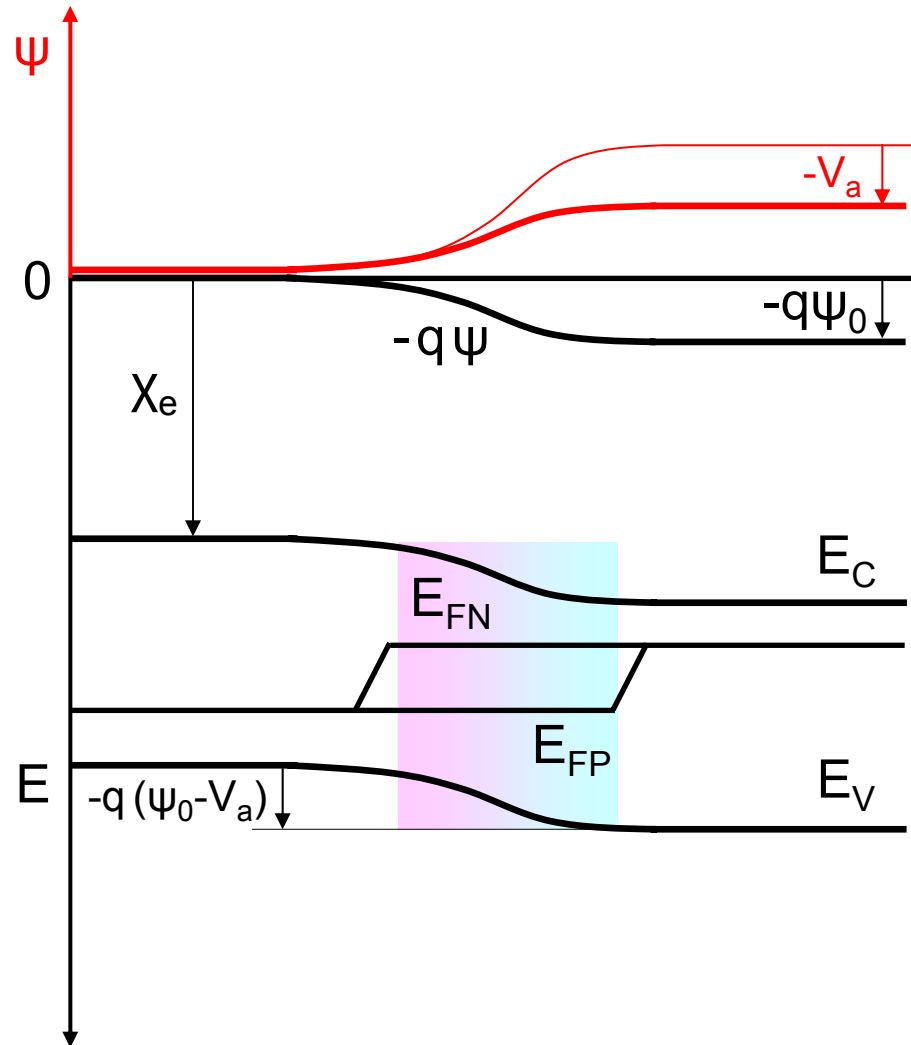

p-n junction diode

Applied voltage: Forward bias

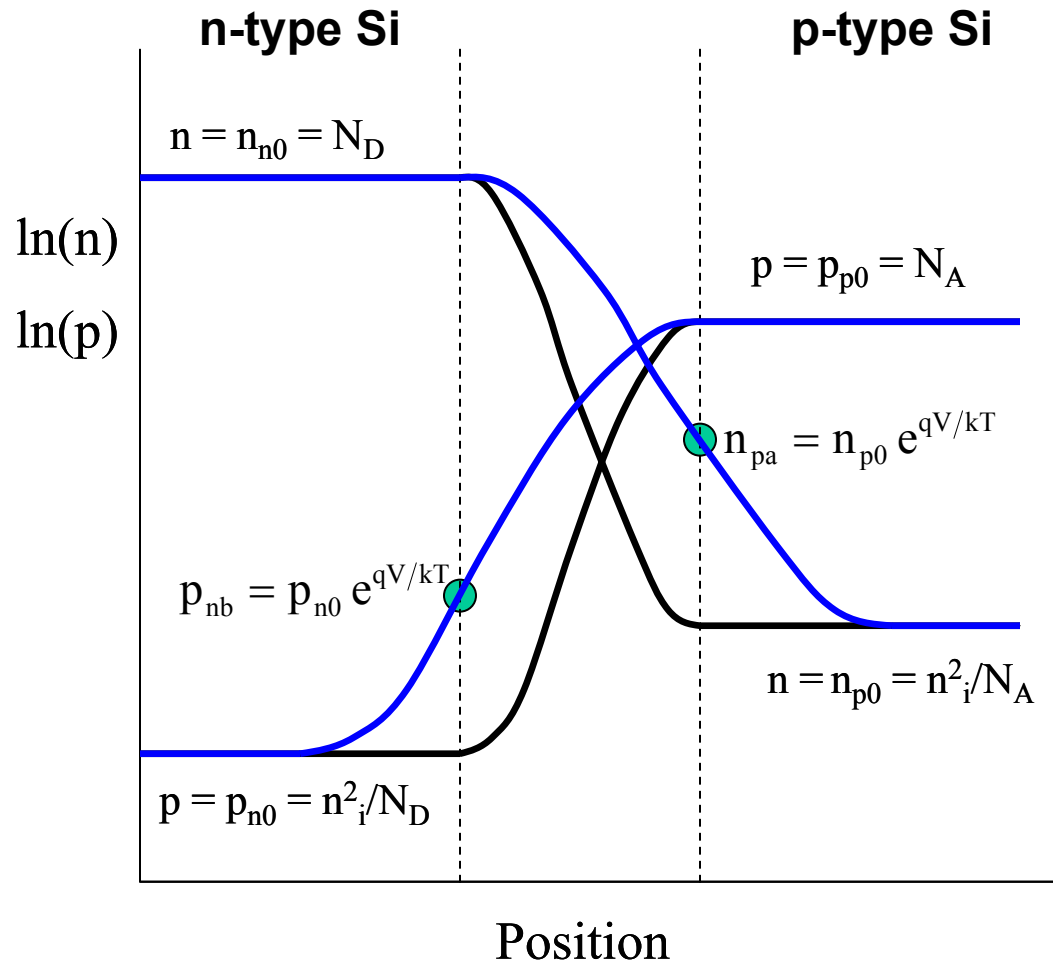

p-n junction diode

Applied voltage: Reverse bias

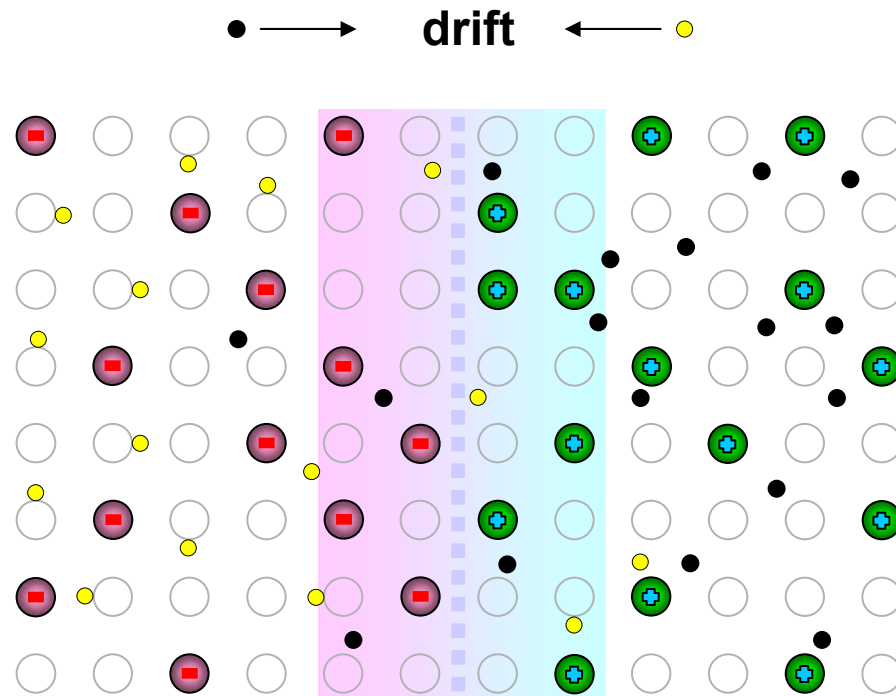

p - n junction diode

Applied voltage: Reverse bias

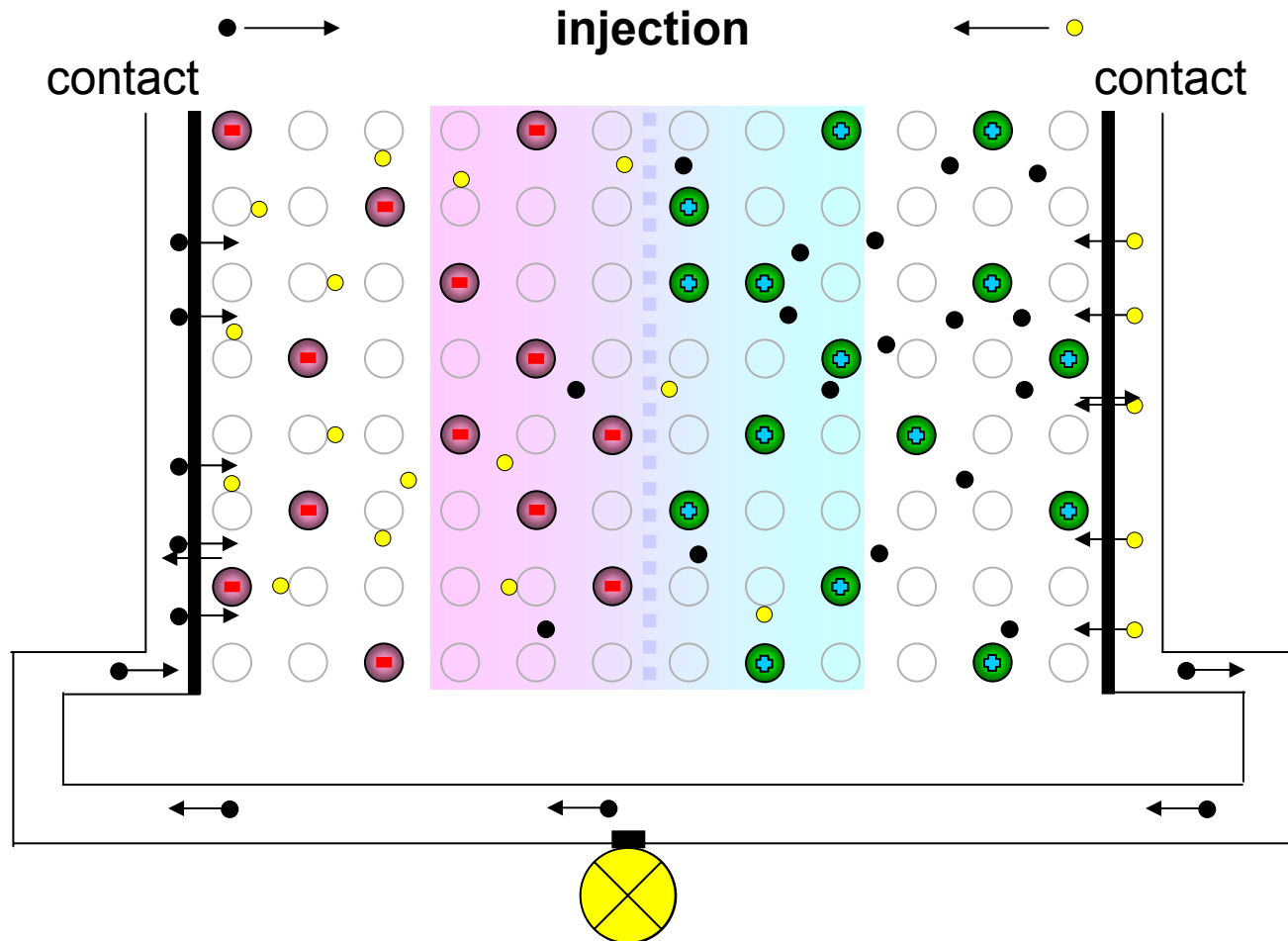

p-n junction diode

Applied voltage: Reverse bias

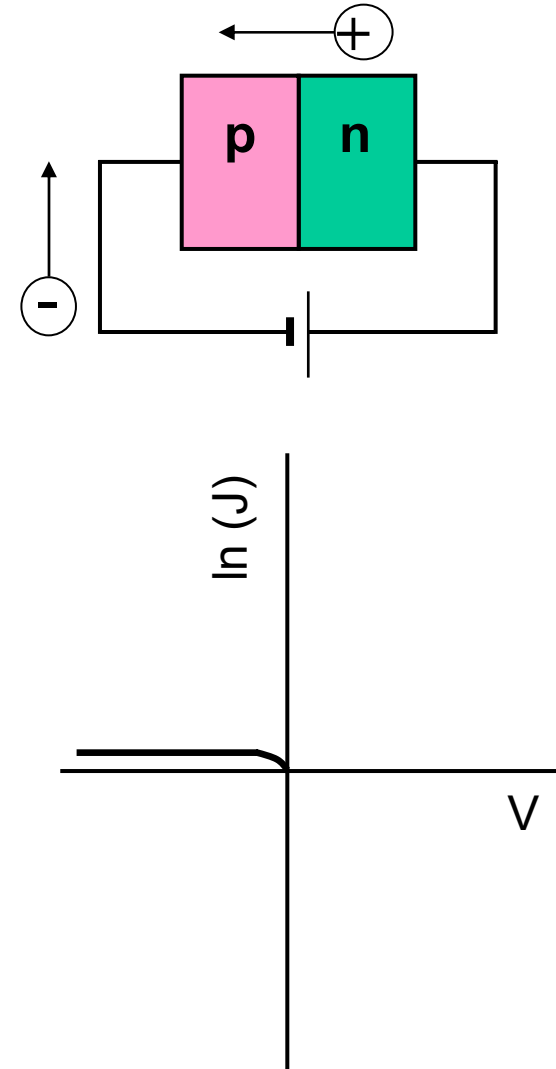
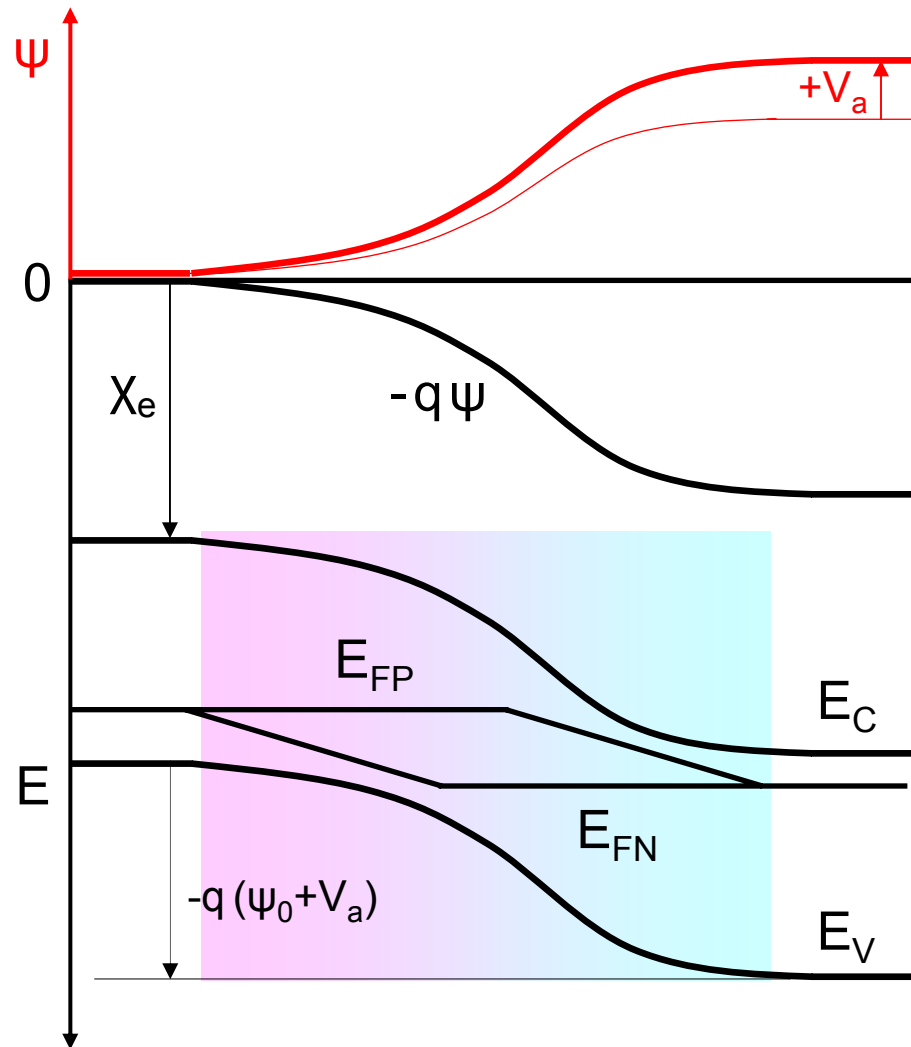

p-n junction diode

Applied voltage:

Application of bias voltage V

- Injection of minority carries

$$p_{nb} = p_{n0} e^{qV/kT}$$

$$n_{pa} = n_{p0} e^{qV/kT}$$

- Ideal diode dark current:

$$I = I_0 \left(e^{qV/kT} - 1 \right)$$

$$I_0 = A \left(\frac{q D_n n_i^2}{L_n N_A} + \frac{q D_p n_i^2}{L_p N_D} \right)$$

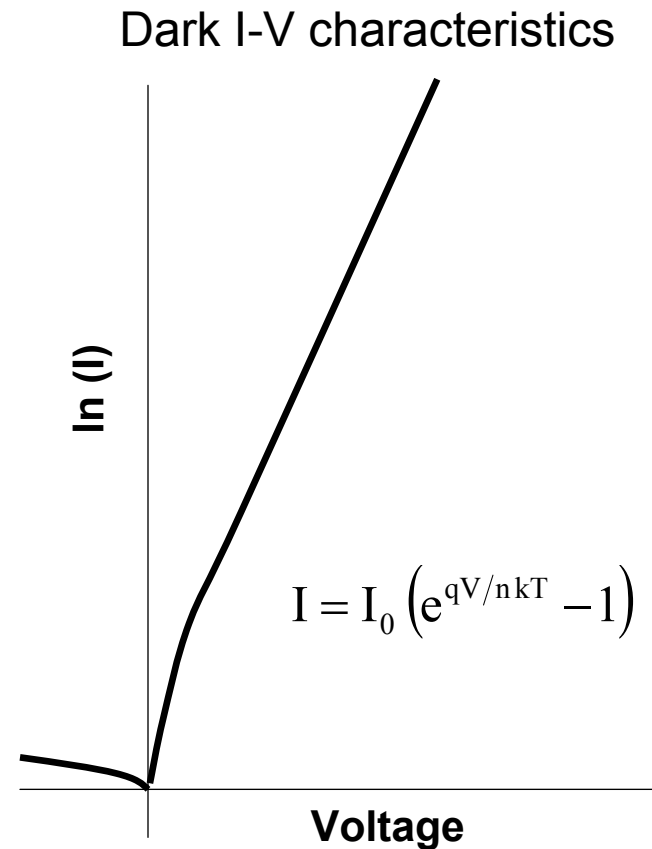

p-n junction

Illuminated *p-n* junction: Uniform generation rate G

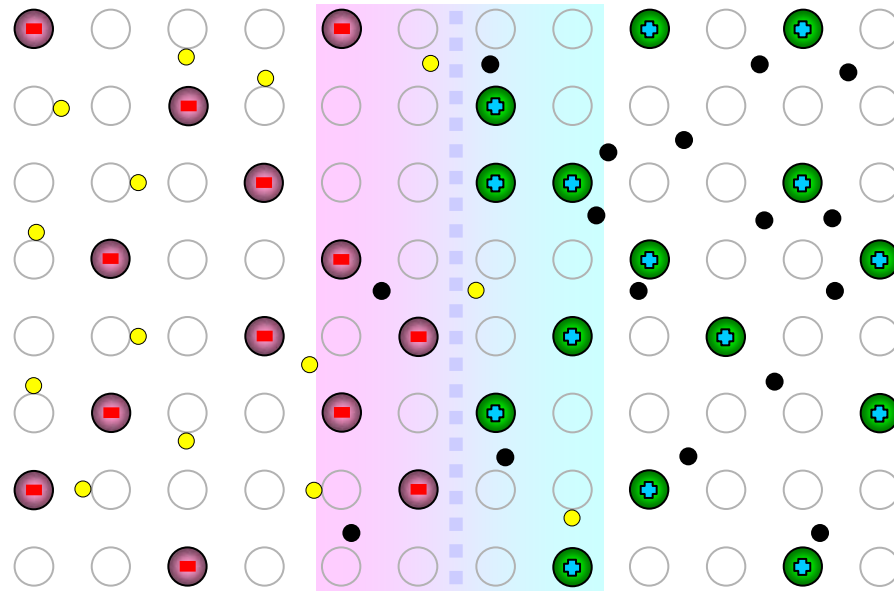

p - n junction

Illuminated p - n junction: Uniform generation rate G

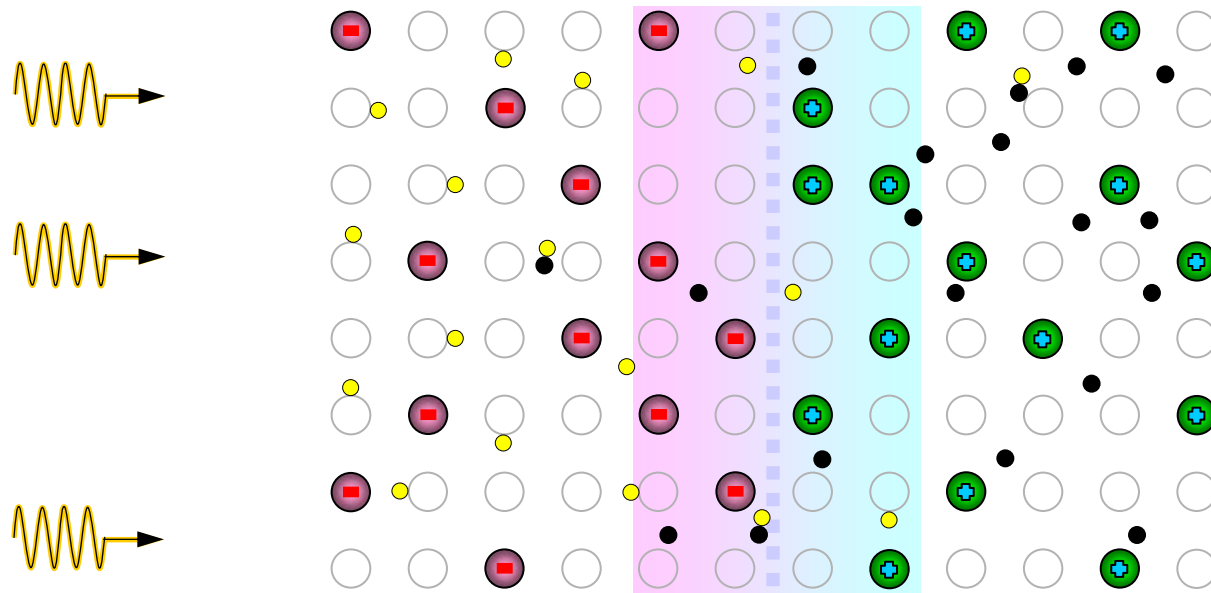

p - n junction

Illuminated p - n junction: Uniform generation rate G

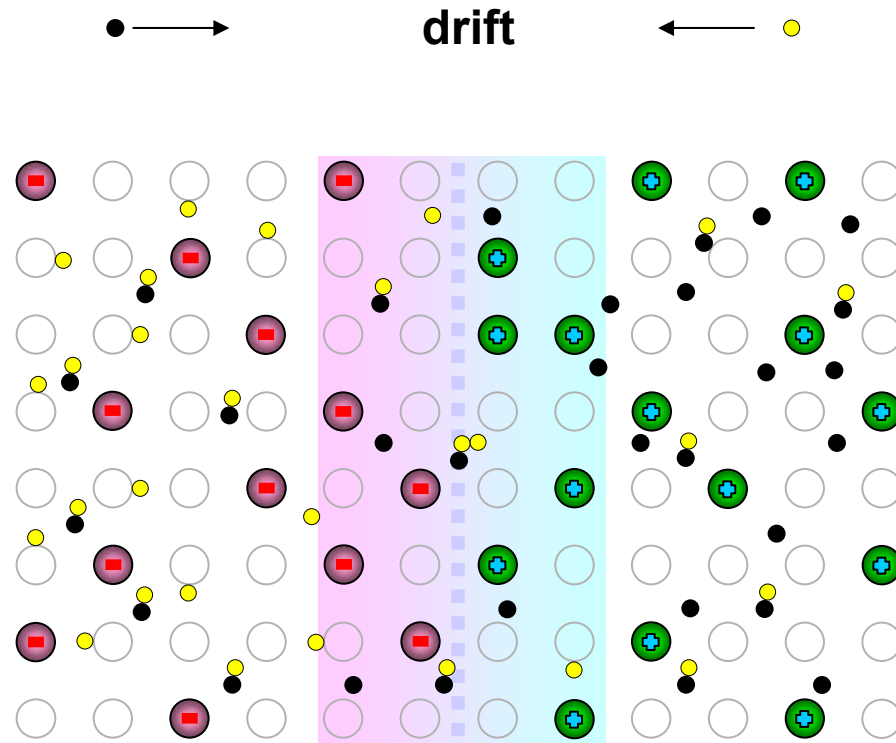

p - n junction

Illuminated p - n junction: Uniform generation rate G

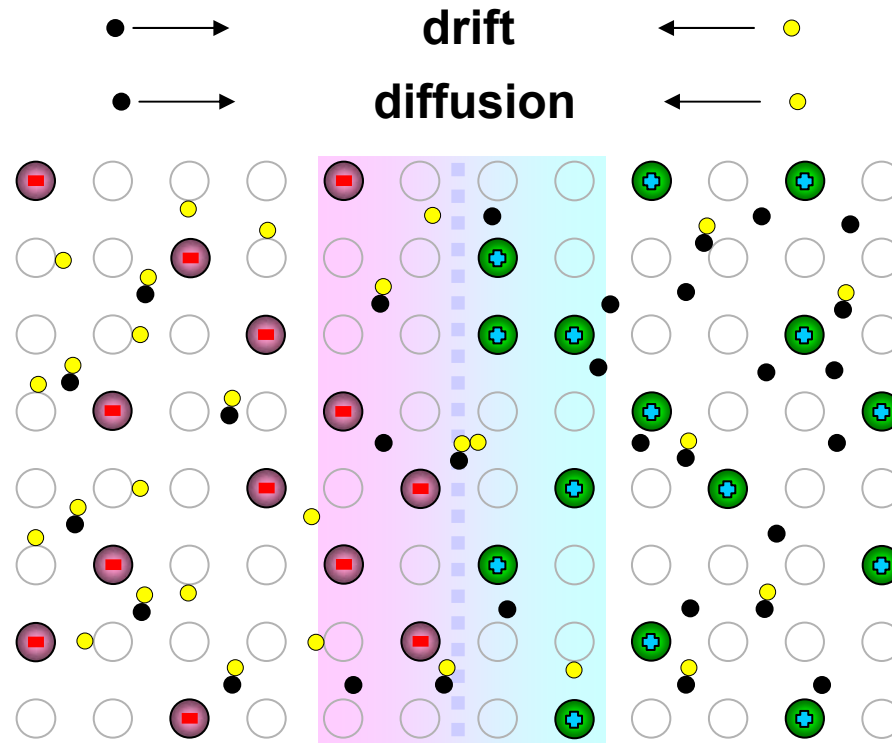

p - n junction

Illuminated p - n junction: Uniform generation rate G

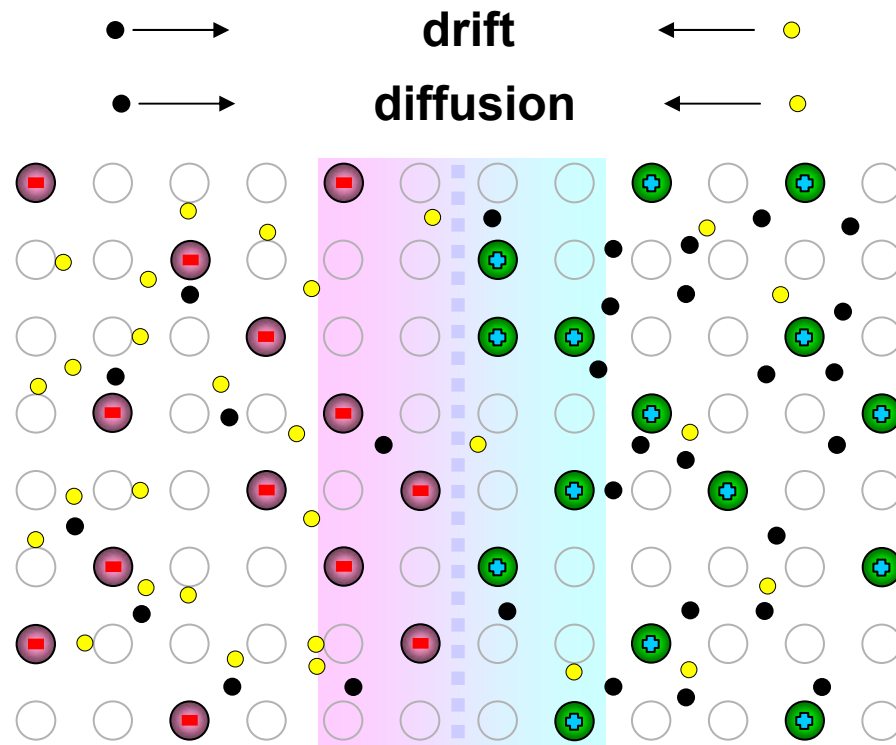

p-n junction

Illuminated *p-n* junction: Uniform generation rate G

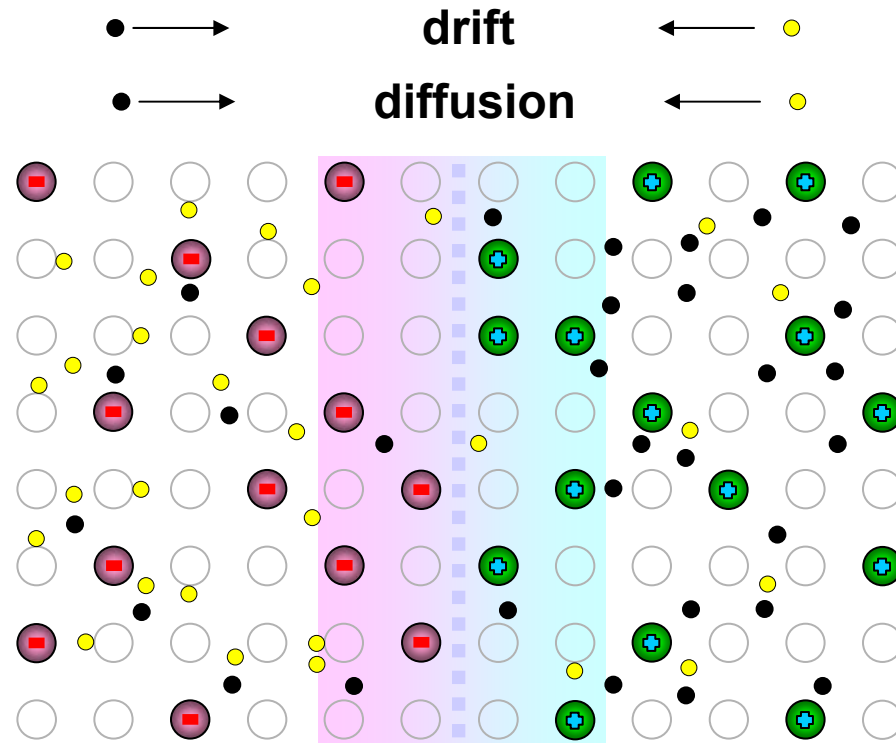

p - n junction diode

Illuminated p - n junction: Uniform generation rate G

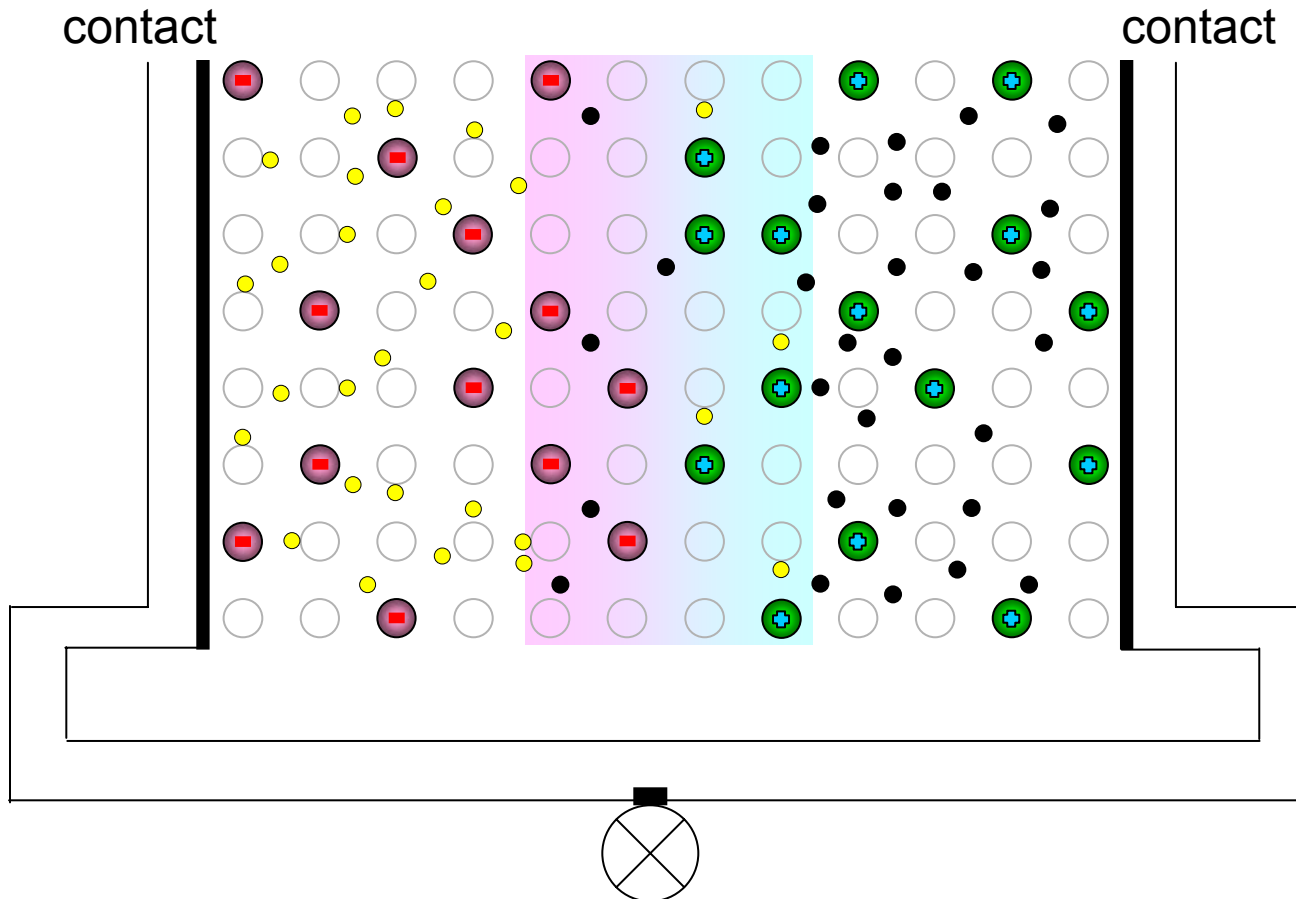

p - n junction diode

Illuminated p - n junction: Uniform generation rate G

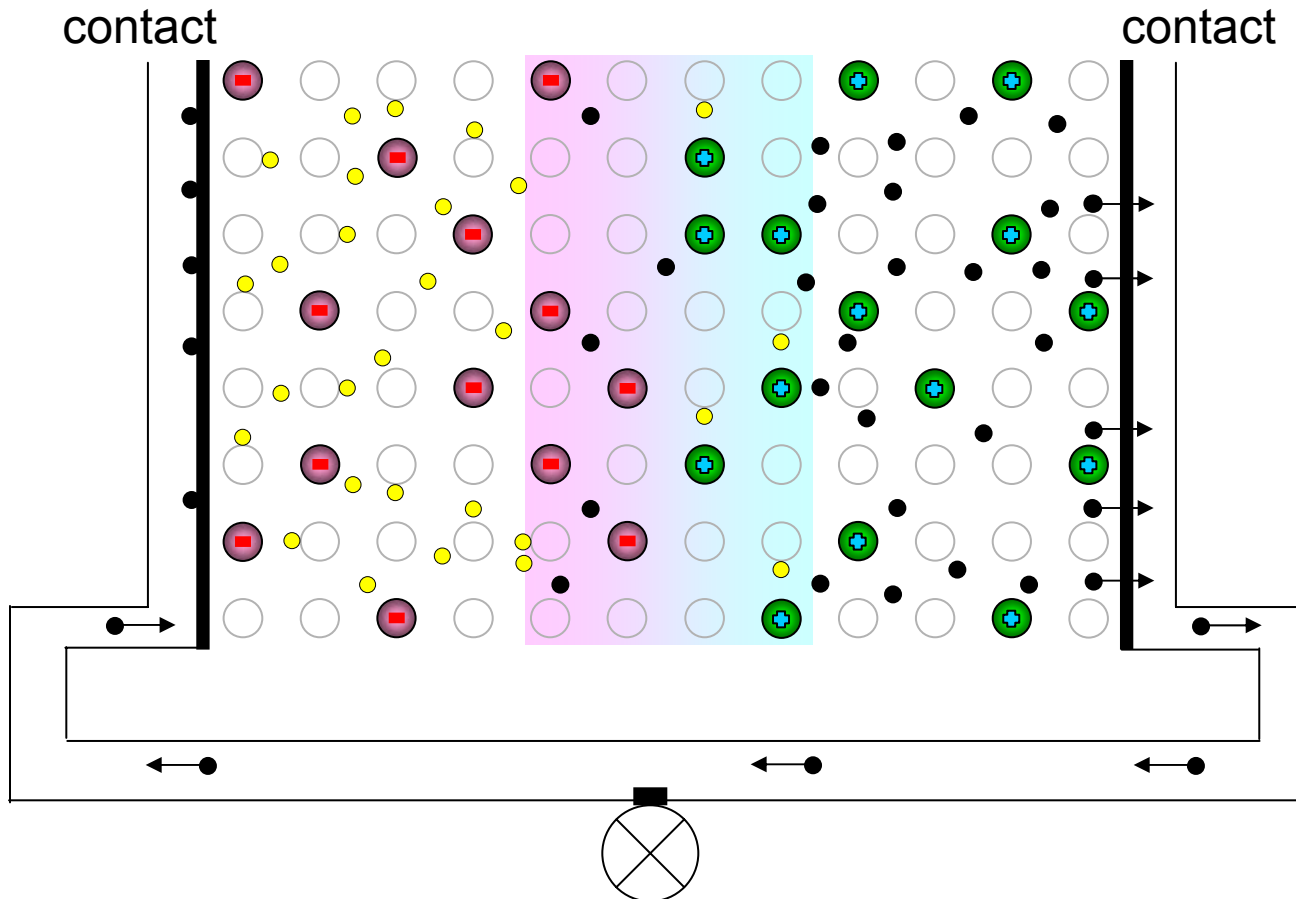

p - n junction

Illuminated p - n junction: Uniform generation rate G

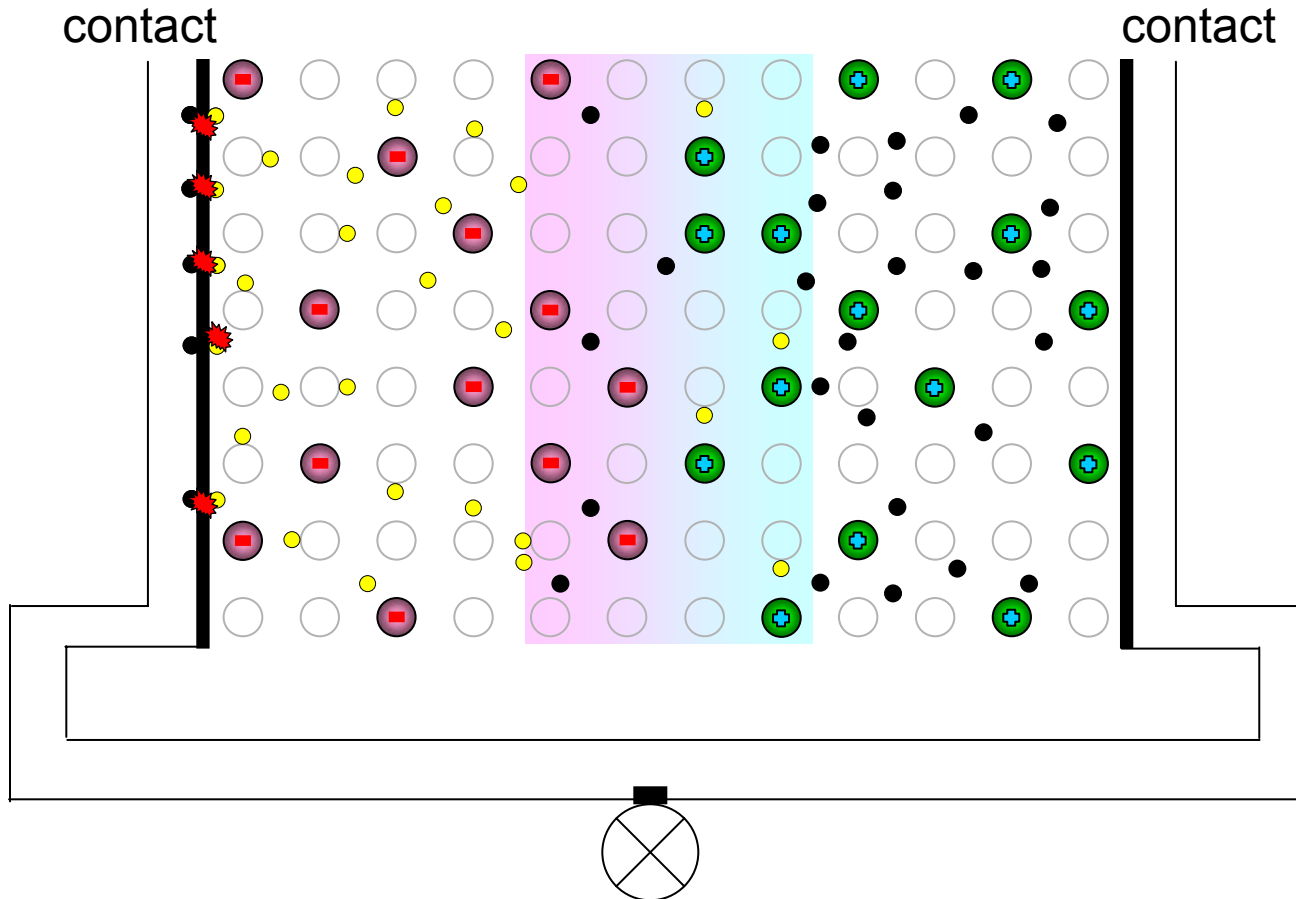

p - n junction

Illuminated p - n junction: Uniform generation rate G

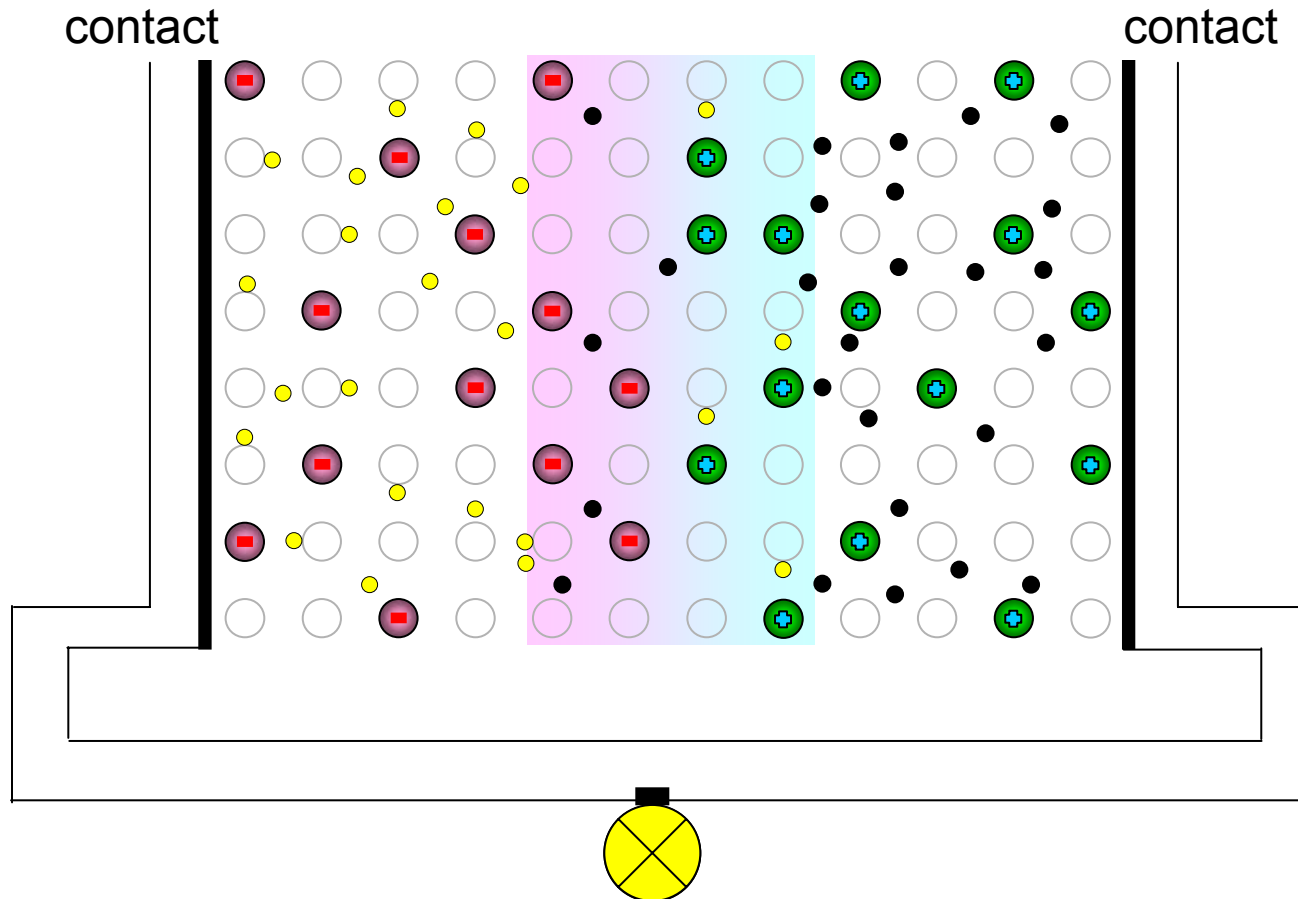

p-n junction

Illuminated *p-n* junction: Uniform generation rate G

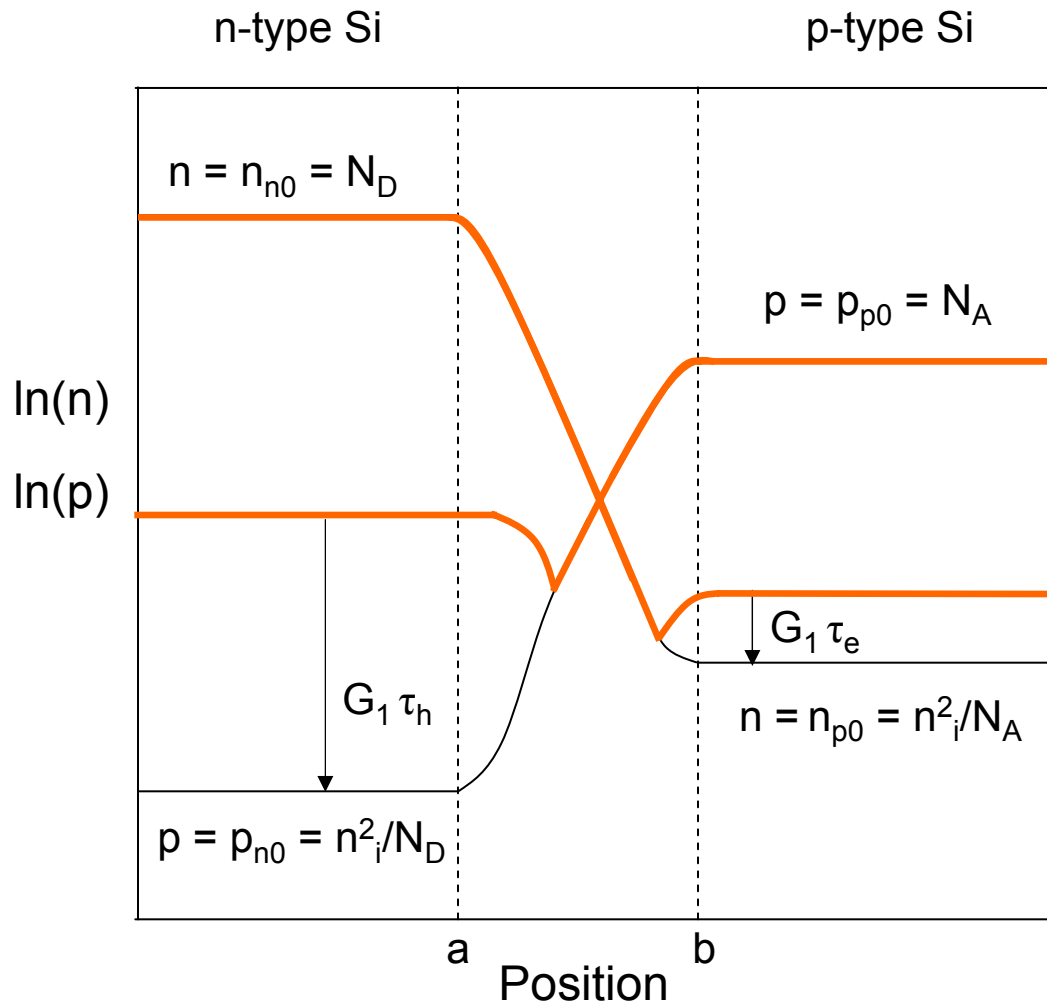

p-n junction

Illuminated *p-n junction*: Uniform generation rate G

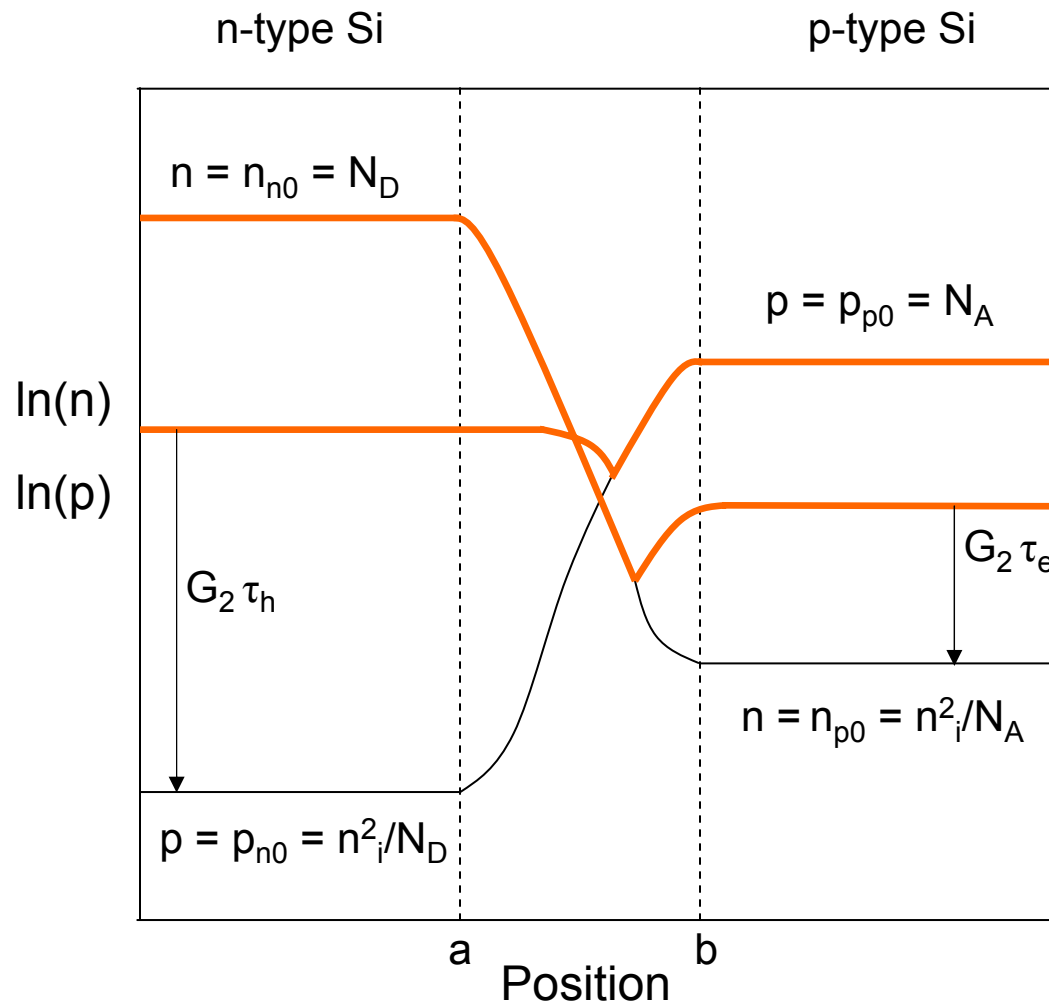

p-n junction

Illuminated *p-n* junction: Uniform generation rate G

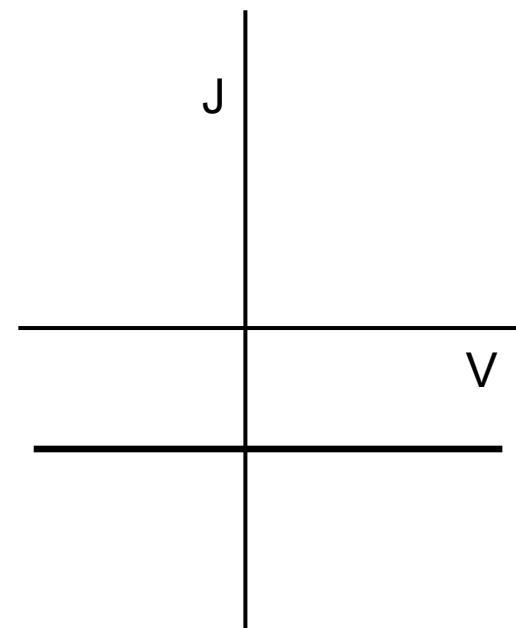
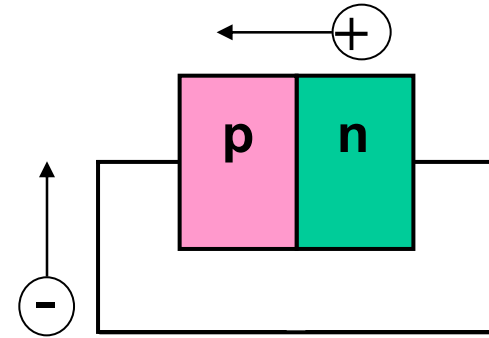
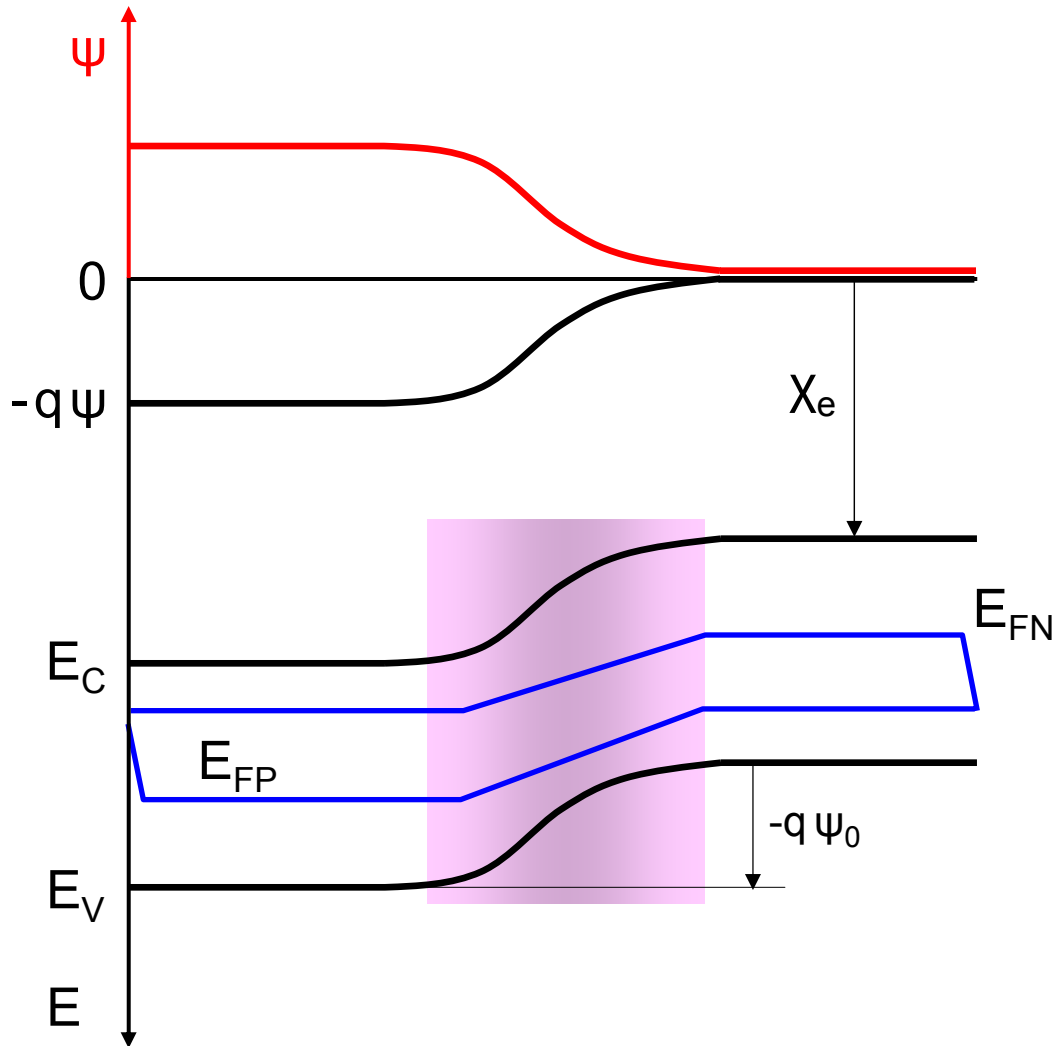

p-n junction

Illuminated *p-n* junction: Uniform generation rate G

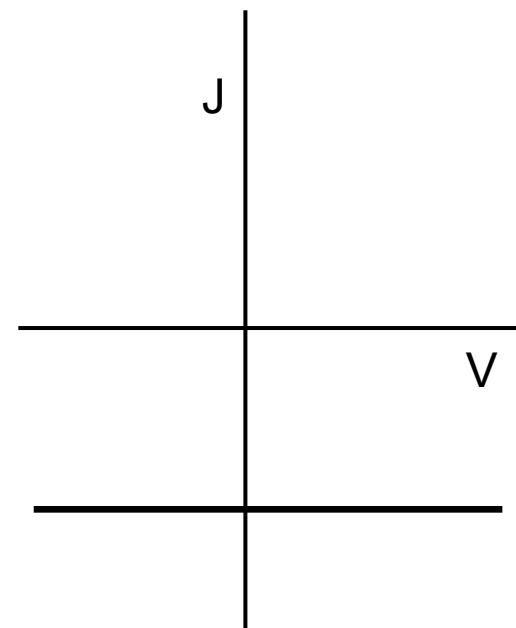
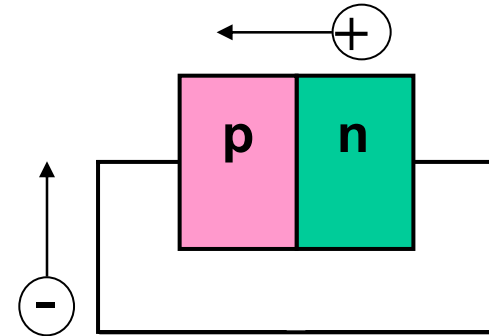
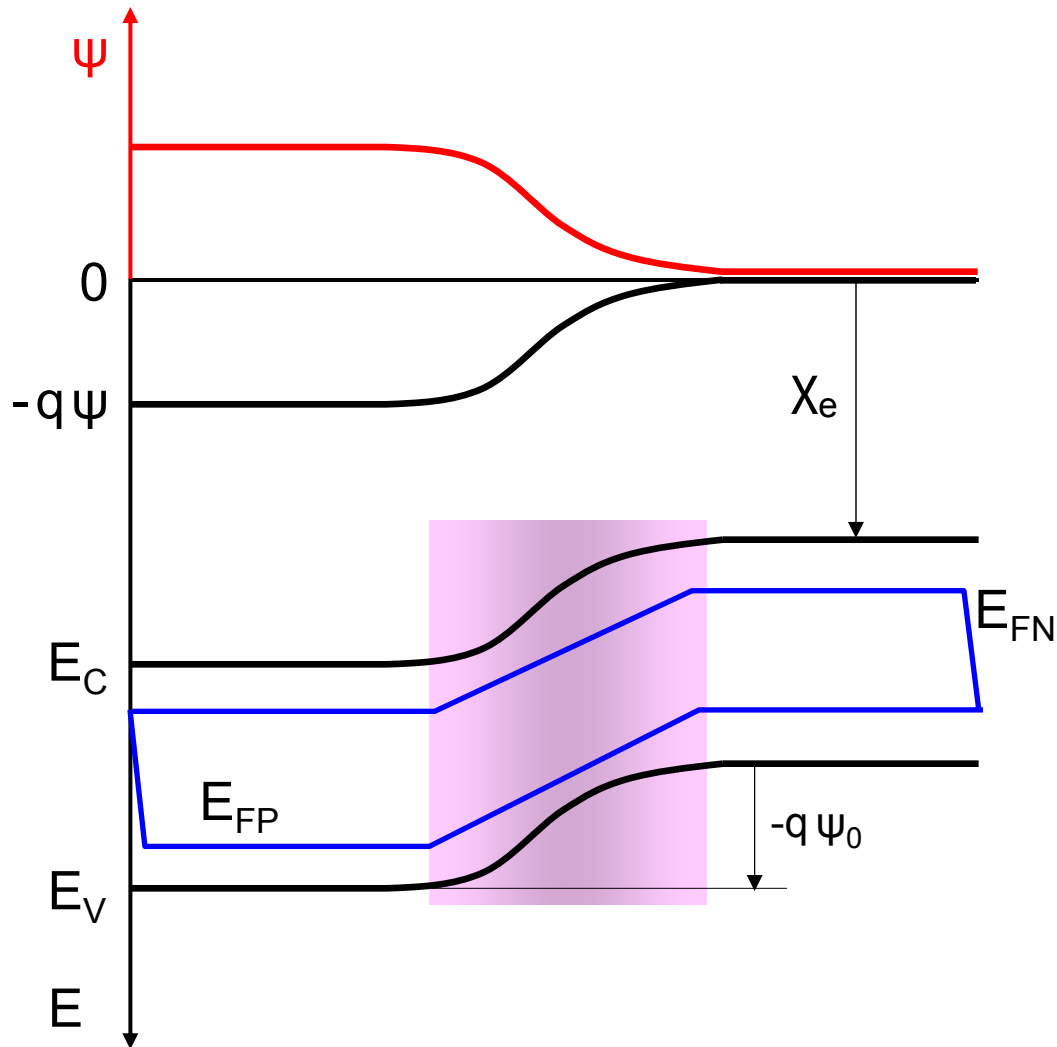

p-n junction

Illuminated *p-n* junction: Uniform generation rate G

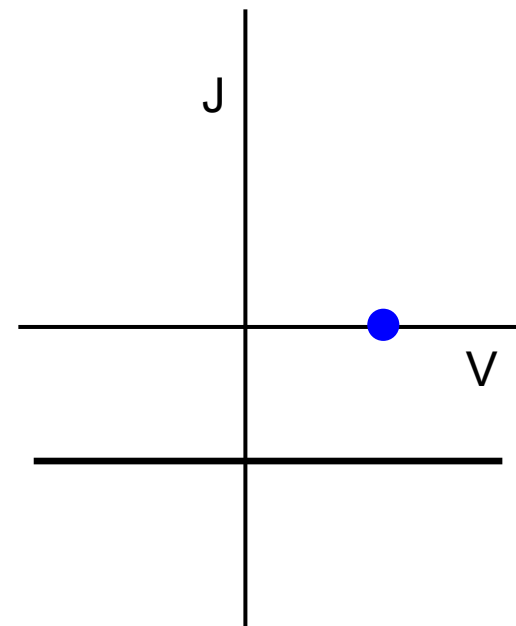
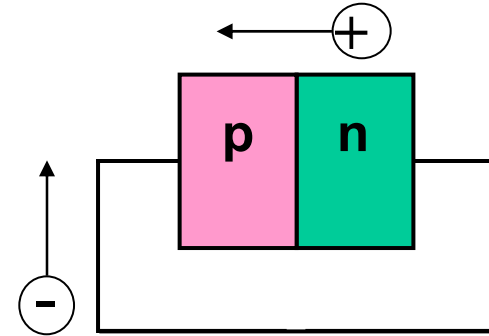
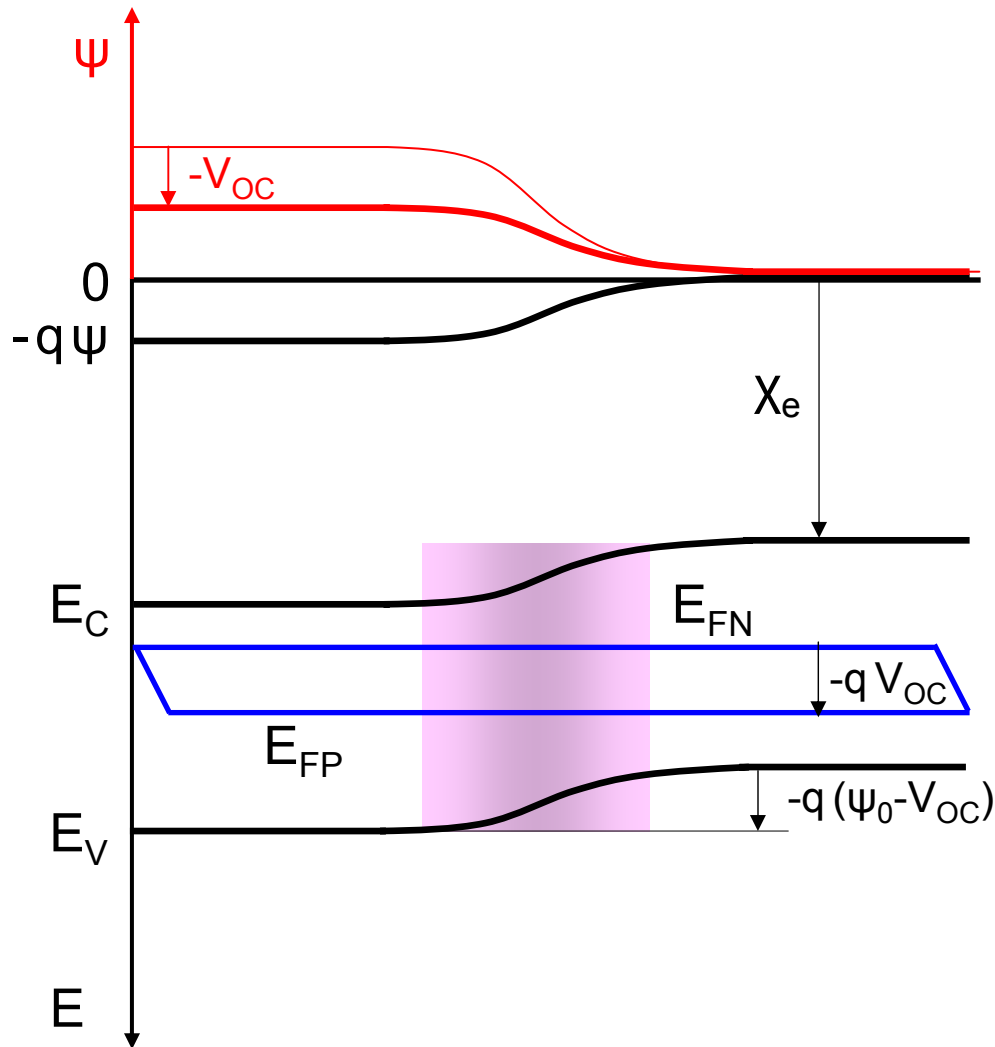

p-n junction

Illuminated *p-n* junction: Uniform generation rate G

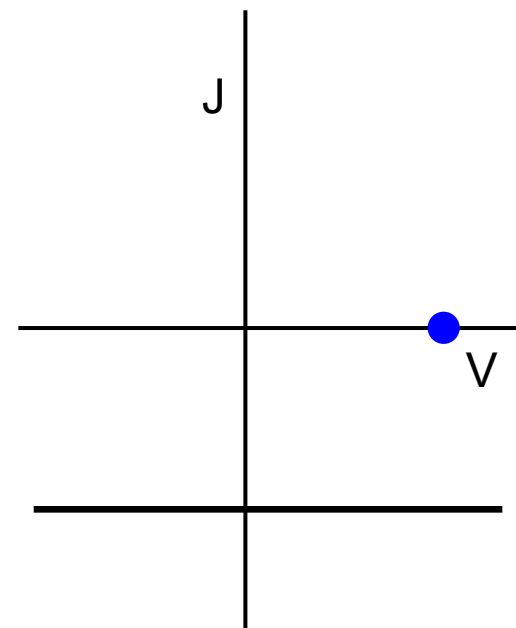
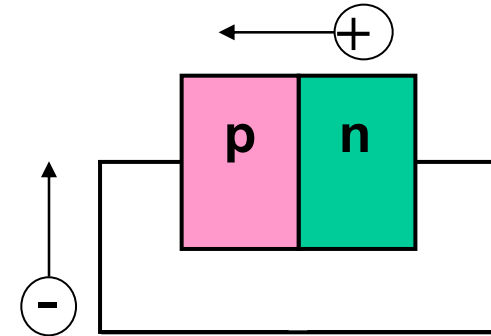
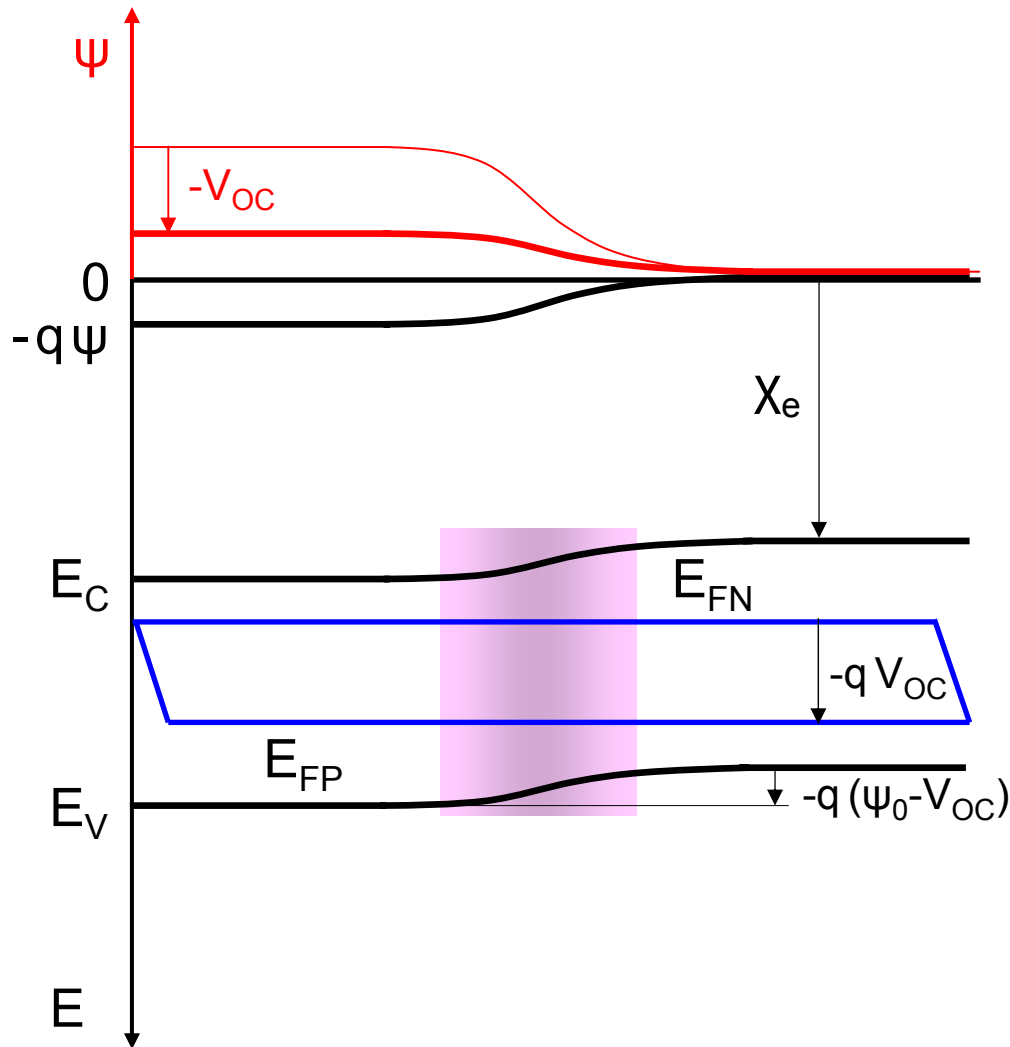

p-n junction

Illuminated *p-n* junction: Uniform generation rate G

- Constant generation rate G
- Photocurrent:

$$I_L = q A G (L_e + W + L_h)$$

- Dark diode current:

$$I_D = I_0 \left(e^{qV/kT} - 1 \right)$$

- Total current :

$$I_T = I_0 \left(e^{qV/kT} - 1 \right) - I_L$$

Illuminated I-V characteristics

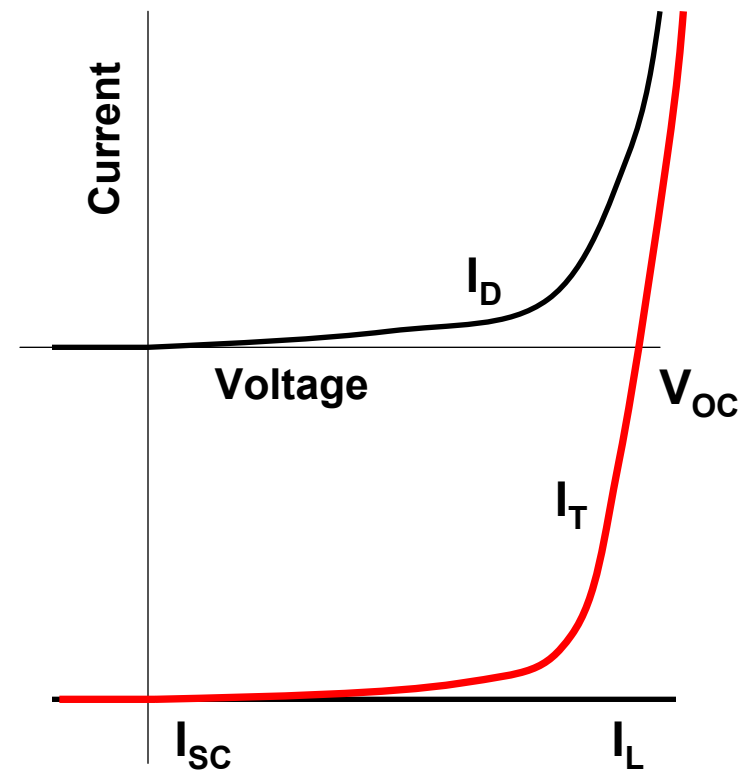

Solar cell operating principles

1. **Absorption** of photons \Rightarrow generation of electron-hole pairs
2. **Separation** of carriers in the internal electric field created by p - n junction and **collection** at the electrodes \Rightarrow potential difference and current in the external circuit
3. Potential difference at the electrodes of a p - n junction \Rightarrow **injection** and **recombination** of carriers \Rightarrow losses

The resulting current in the external circuit: $I = I_L - I_D$ (V)

- photocurrent I_L
- dark (diode) current I_D